



MINMAX[®]

AMF-15 Series

Electric Characteristic Note

AMF-15 Series EC Note

AC-DC POWER MODULE 15W

Features

- ▶ Ultra Compact Size 2.06x1.07x0.93 "
- ▶ Fully Encapsulated Plastic Case for PCB, Chassis and DIN-Rail Mounting Version
- ▶ Universal Input 85-264VAC, 90-370VDC, 47-440Hz
- ▶ I/O Isolation 3000VAC with Reinforced Insulation
- ▶ No Min. Load Requirement & Low no-load power consumption
- ▶ Operating Ambient Temp. Range -40°C to +70°C
- ▶ Overload/Voltage and Short Circuit Protection
- ▶ EMI Emission EN55014-1/55032 Class B Approved
- ▶ EMS Immunity EN61000-4-2,3,4,5,6,8,11 Approved
- ▶ Safety Approval to UL/cUL/IEC/EN 62368-1, IEC/EN 60335-1 & CE Marking



Applications

- ▶ Distributed power architectures
- ▶ Workstations
- ▶ Computer equipment
- ▶ Communications equipment

Product Overview

The MINMAX AMF-15 series is a new generation of fully encapsulated AC-DC power supply modules with ultra-compact size for higher power density and space saving.

The product features universal AC input 85-264VAC and wider DC input 90-370VDC, regulated output voltages 5.1, 12, 15, 24, 48VDC ; I/O Isolation 3000VAC with Reinforced Insulation ; EMI emission EN55014-1/32 Class B and EMS immunity EN 61000-4 standards approved ; no min. load requirement and low no-load power consumption ; abnormal protection mechanism with output overload, short circuit and overvoltage protections.

The AMF-15 series equips with PCB, Chassis and DIN-Rail Mounting Version for flexible installation and comply with UL/IEC/EN 62368-1 & IEC/EN 60335-1 for safety usage. It provides a cost effective solution especially for space critical applications in industrial and household electronic equipment.

Table of contents

Model Selection Guide	P2	Screw terminal with DIN Rail Mounting	P10
Input Specifications	P2	Package Specifications Chassis Mounting with JST connection	P11
Output Specifications	P2	Package Specifications for JST connection with DIN Rail Mounting	P11
General Specifications	P2	JST connection with DIN Rail Mounting	P11
EMC Specifications	P3	Recommended Pad Layout	P12
Environmental Specifications	P3	Packaging Information	P13
Characteristic Curves	P4	Wave Soldering Considerations	P14
Package Specifications PCB Mounting	P9	Hand Welding Parameter	P14
Package Specifications Chassis Mounting with screw terminal	P9	Part Number Structure	P15
Package Specifications for screw terminal with DIN Rail Mounting	P10	MTBF and Reliability	P15

Model Selection Guide

Model Number	Output Voltage	Output Power	Output Current	Input Current	Max. capacitive Load	Efficiency (typ.)
			Max.	115VAC, 60Hz		@Max. Load
	VDC	W	mA	mA(typ.)	μF	%
AMF-15S051	5.1	15.3	3000	318	3300	80
AMF-15S12	12	15	1250	306	560	85
AMF-15S15	15	15	1000	306	330	86
AMF-15S24	24	15	625	299	220	86
AMF-15S48	48	15.02	313	306	47	86

Input Specifications

Parameter	Conditions / Model	Min.	Typ.	Max.	Unit
AC Input Voltage Range	All Models	85	---	264	VAC
AC Input Frequency Range		47	---	440	Hz
DC Input Voltage Range		90	---	370	VDC
No-Load Power Consumption	115VAC	---	---	150	mW
	230VAC	---	---	300	mW
Inrush Current (Cold Start at 25°C)	115VAC	---	---	25	A
	230VAC	---	---	45	A

Output Specifications

Parameter	Conditions / Model	Min.	Typ.	Max.	Unit	
Output Voltage Setting Accuracy		---	±1.0	±2.0	%	
Line Regulation	Vin=Min. to Max. @Full Load	---	---	±0.5	%	
Load Regulation	Io=0% to 100%	---	---	±1.0	%	
Minimum Load	No minimum Load Requirement					
Ripple & Noise	0-20 MHz Bandwidth	5.1VDC Output Model	---	---	80	mV _{P-P}
		Other Output Models	---	---	1	%V _{PP} of Vo
Temperature Coefficient		---	±0.01	±0.02	%/°C	
Over Load Protection	auto-recovery (long term overload condition may cause damage)	---	150	---	%Inom.	
Short Circuit Protection	Hiccup mode, Automatic Recovery					

General Specifications

Parameter	Conditions	Min.	Typ.	Max.	Unit
I/O Isolation Voltage	60 Seconds	3000	---	---	VAC
I/O Isolation Resistance	500 VDC	10	---	---	GΩ
Switching Frequency		---	---	125	kHz
Hold-up Time	115VAC, 60Hz	8	---	---	ms
	230VAC, 50Hz	40	---	---	ms
MTBF (calculated)	MIL-HDBK-217F@25°C, Ground Benign	458,989	---	---	Hours
Safety Approvals	UL/cUL 62368-1 recognition(UL certificate), IEC/EN 62368-1(CB-report)				
	IEC/EN 60335-1, 61558-1, 61558-2-16 recognition(CB-report)				

EMC Specifications				
Parameter	Standards & Level			Performance
General	Compliance with EN 61204-3 Switch mode power supplies			
EMI	Conduction	EN 55014-1, EN 55032	Without external components	Class B
	Radiation			
EMS	EN 55014-2, EN 55024, EN 55035			
	ESD	Direct discharge	Indirect discharge HCP & VCP	
		EN 61000-4-2 Air \pm 8kV	Contact \pm 6kV	
	Radiated immunity	EN 61000-4-3 10V/m		
	Fast transient	EN 61000-4-4 \pm 2kV		
	Surge	EN 61000-4-5 \pm 1kV		
	Conducted immunity	EN 61000-4-6 10Vrms		
	PFMF	EN 61000-4-8 30A/m		
	Dips	EN 61000-4-11 30% 10ms		
Interruptions	EN 61000-4-11 >95% 5000ms			

Environmental Specifications				
Parameter	Min.	Max.	Unit	
Operating Ambient Temperature Range (See Power Derating Curve)	-40	+70	°C	
Storage Temperature Range	-40	+85	°C	
Humidity (non condensing)	---	95	% rel. H	
Lead Temperature (1.5mm from case for 10Sec.)	---	260	°C	

Notes	
1	All specifications typical at Ta=+25°C, resistive load, 115VAC, 60Hz input voltage and after warm-up time rated output current unless otherwise noted.
2	We recommend to protect the converter by a slow blow fuse in the input supply line.
3	Other input and output voltage may be available, please contact MINMAX.
4	The continuous operation on DC input voltage of 80VDC to 370VDC is available after start-up at 90VDC.
5	Specifications are subject to change without notice.

Characteristic Curves

All test conditions are at 25°C The figures are identical for AMF-15S051

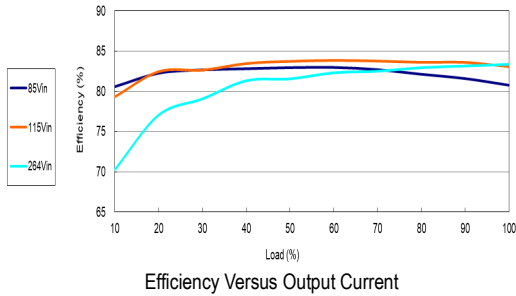

Efficiency Versus Output Current

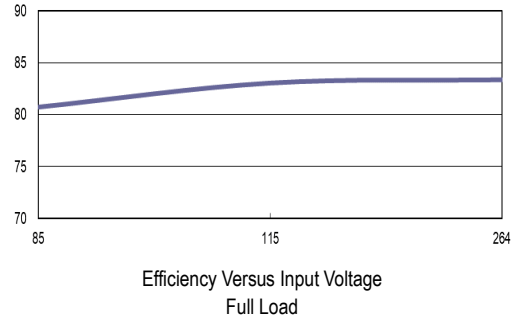

Efficiency Versus Input Voltage Full Load

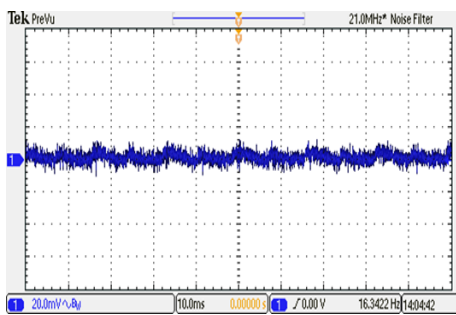

Typical Output Ripple and Noise
 $V_{in}=V_{in\ nom}$; Full Load

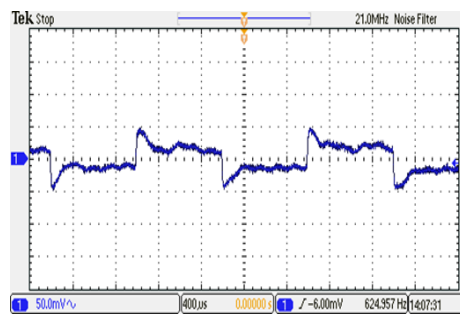

Transient Response to Dynamic Load Change
from 100% to 75% of Full Load ; $V_{in}=V_{in\ nom}$

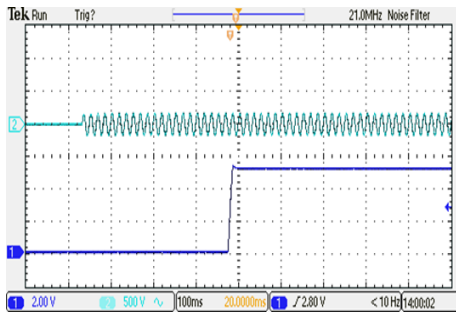

Typical Input Start-up and Output Rise Characteristic
 $V_{in}=V_{in\ nom}$; Full Load

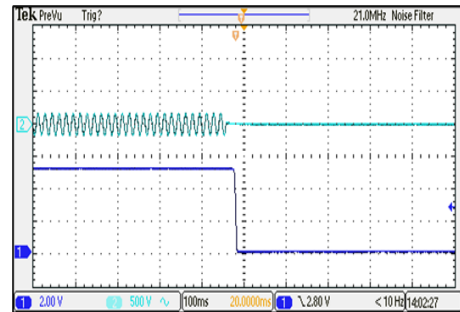

Typical Input Hold-up and Output Rise Characteristic
 $V_{in}=V_{in\ nom}$; Full Load

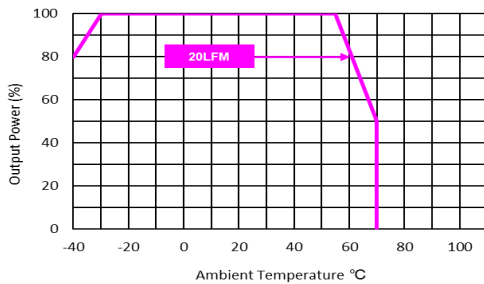

Derating Output Current Versus Ambient Temperature
 $V_{in}=V_{in\ nom}$

Characteristic Curves

All test conditions are at 25°C The figures are identical for AMF-15S12

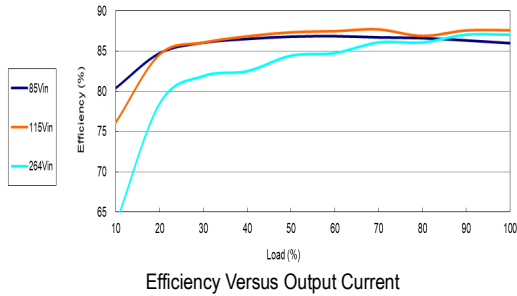

Efficiency Versus Output Current

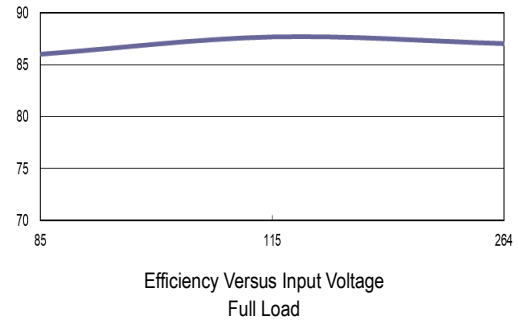

Efficiency Versus Input Voltage Full Load

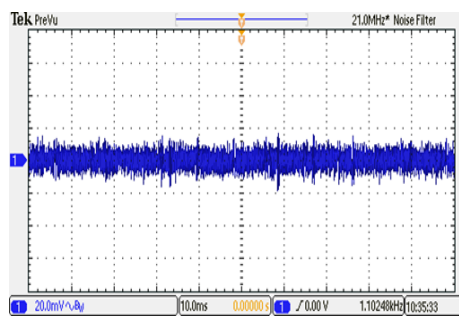

Typical Output Ripple and Noise
 $V_{in}=V_{in\ nom}$; Full Load

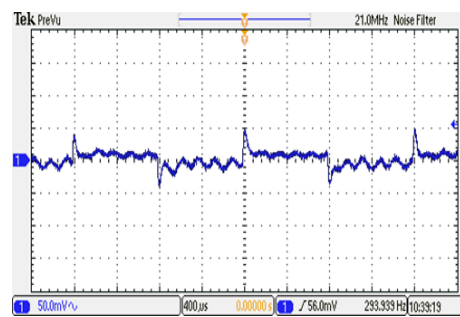

Transient Response to Dynamic Load Change
from 100% to 75% of Full Load; $V_{in}=V_{in\ nom}$

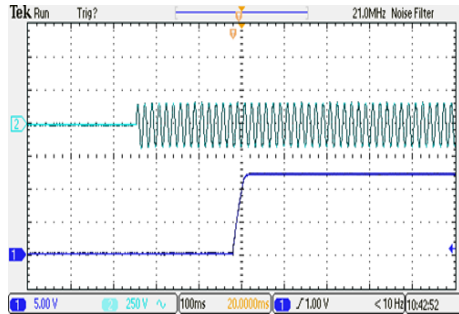

Typical Input Start-up and Output Rise Characteristic
 $V_{in}=V_{in\ nom}$; Full Load

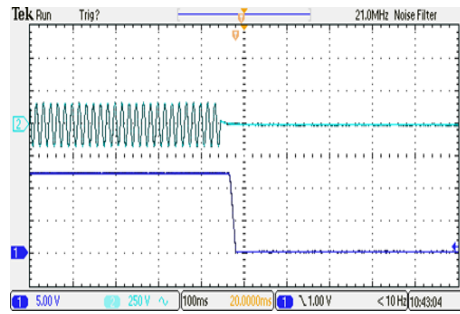

Typical Input Hold-up and Output Rise Characteristic
 $V_{in}=V_{in\ nom}$; Full Load

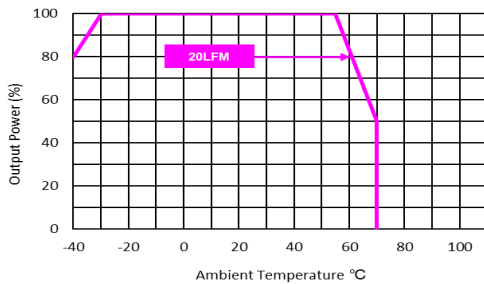

Derating Output Current Versus Ambient Temperature
 $V_{in}=V_{in\ nom}$

Characteristic Curves

All test conditions are at 25°C The figures are identical for AMF-15S15

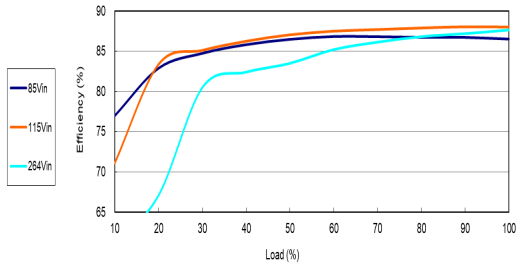

Efficiency Versus Output Current

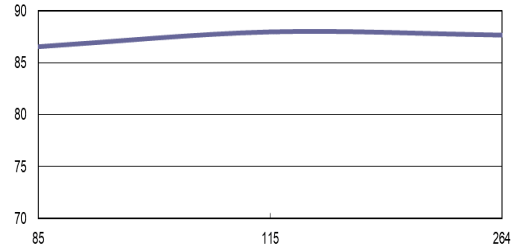

Efficiency Versus Input Voltage Full Load

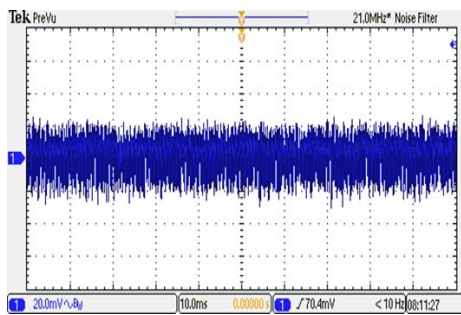

Typical Output Ripple and Noise
 $V_{in}=V_{in\ nom}$; Full Load

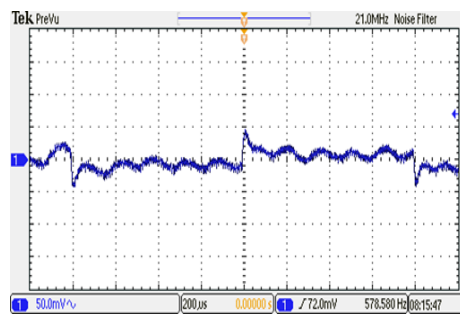

Transient Response to Dynamic Load Change
from 100% to 75% of Full Load ; $V_{in}=V_{in\ nom}$

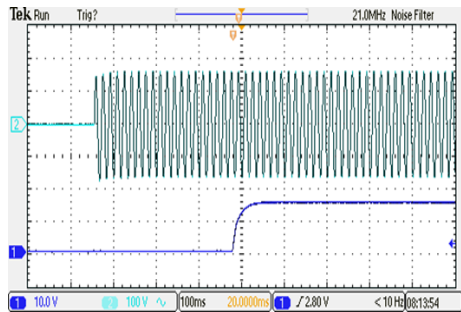

Typical Input Start-up and Output Rise Characteristic
 $V_{in}=V_{in\ nom}$; Full Load

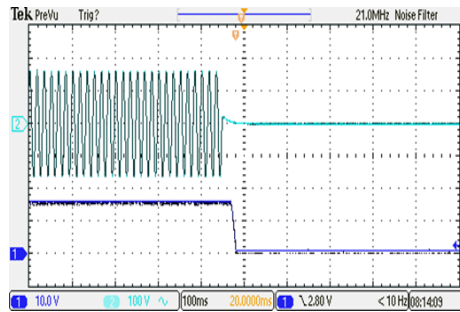

Typical Input Hold-up and Output Rise Characteristic
 $V_{in}=V_{in\ nom}$; Full Load

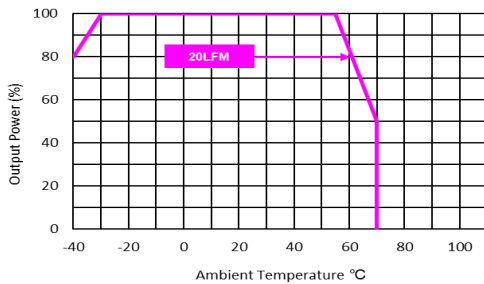

Derating Output Current Versus Ambient Temperature
 $V_{in}=V_{in\ nom}$

Characteristic Curves

All test conditions are at 25°C The figures are identical for AMF-15S24

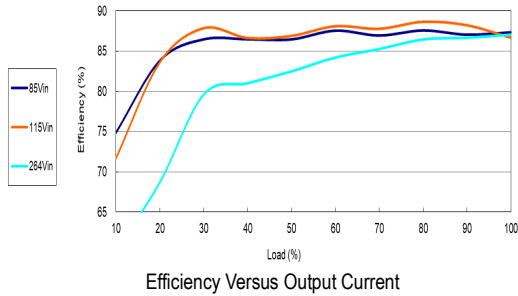

Efficiency Versus Output Current

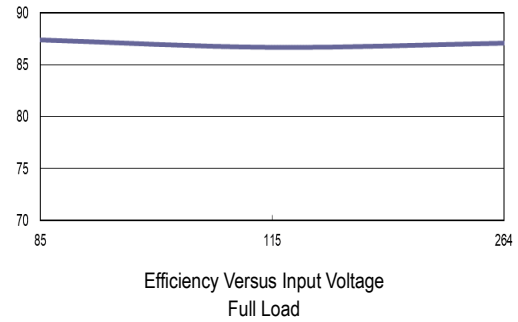

Efficiency Versus Input Voltage Full Load

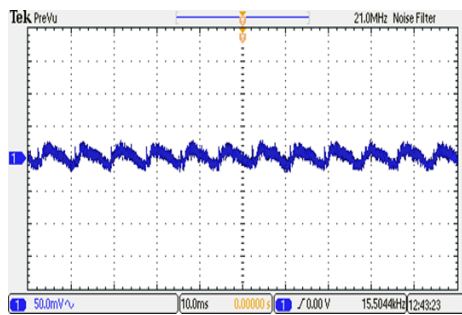

Typical Output Ripple and Noise
 $V_{in}=V_{in\ nom}$; Full Load

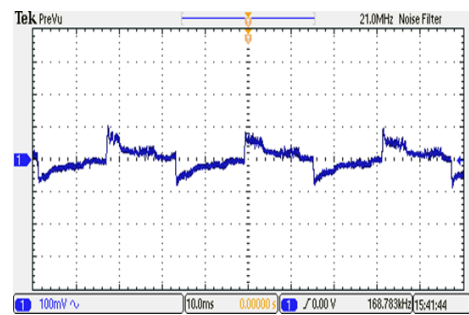

Transient Response to Dynamic Load Change
from 100% to 75% of Full Load ; $V_{in}=V_{in\ nom}$

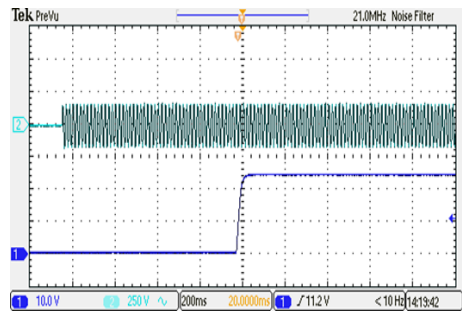

Typical Input Start-up and Output Rise Characteristic
 $V_{in}=V_{in\ nom}$; Full Load

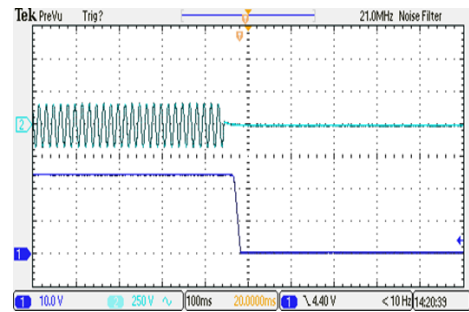

Typical Input Hold-up and Output Rise Characteristic
 $V_{in}=V_{in\ nom}$; Full Load

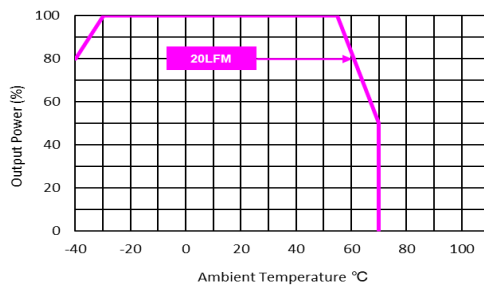

Derating Output Current Versus Ambient Temperature
 $V_{in}=V_{in\ nom}$

Characteristic Curves

All test conditions are at 25°C The figures are identical for AMF-15S48

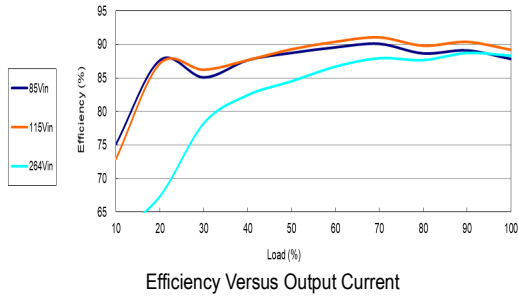

Efficiency Versus Output Current

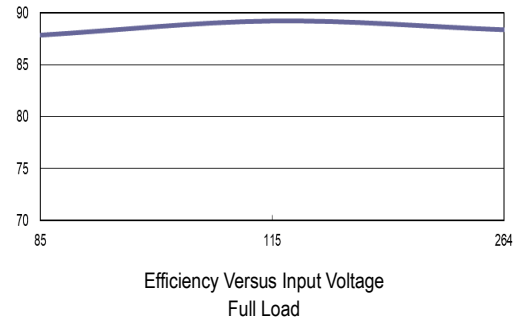

Efficiency Versus Input Voltage Full Load

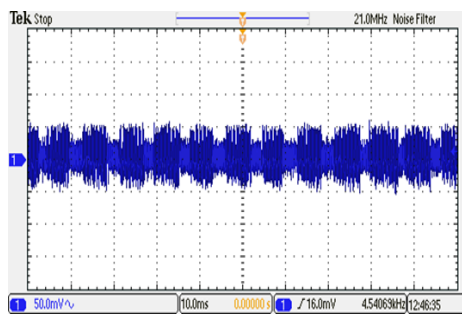

Typical Output Ripple and Noise
 $V_{in}=V_{in\ nom}$; Full Load

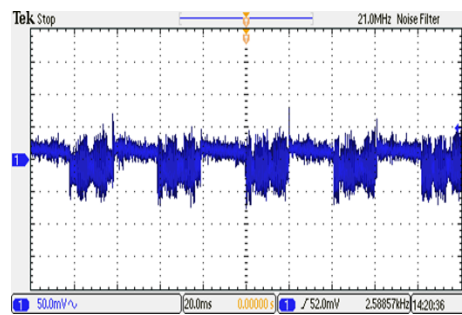

Transient Response to Dynamic Load Change
from 100% to 75% of Full Load ; $V_{in}=V_{in\ nom}$

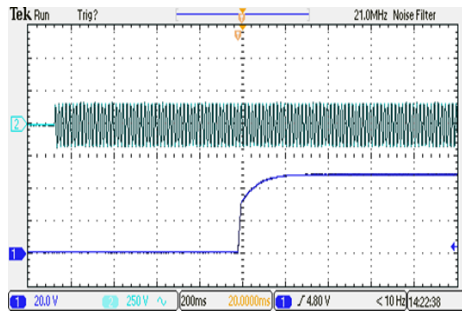

Typical Input Start-up and Output Rise Characteristic
 $V_{in}=V_{in\ nom}$; Full Load

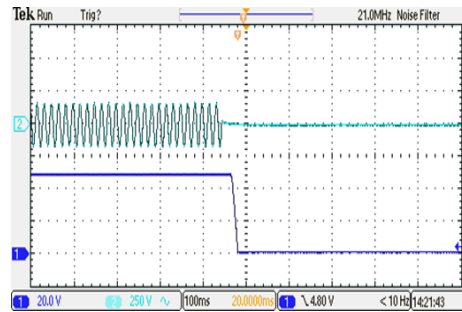

Typical Input Hold-up and Output Rise Characteristic
 $V_{in}=V_{in\ nom}$; Full Load

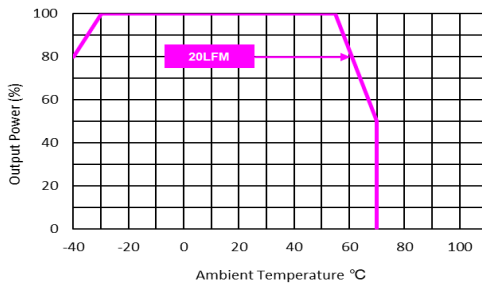

Derating Output Current Versus Ambient Temperature
 $V_{in}=V_{in\ nom}$

Package Specifications PCB Mounting

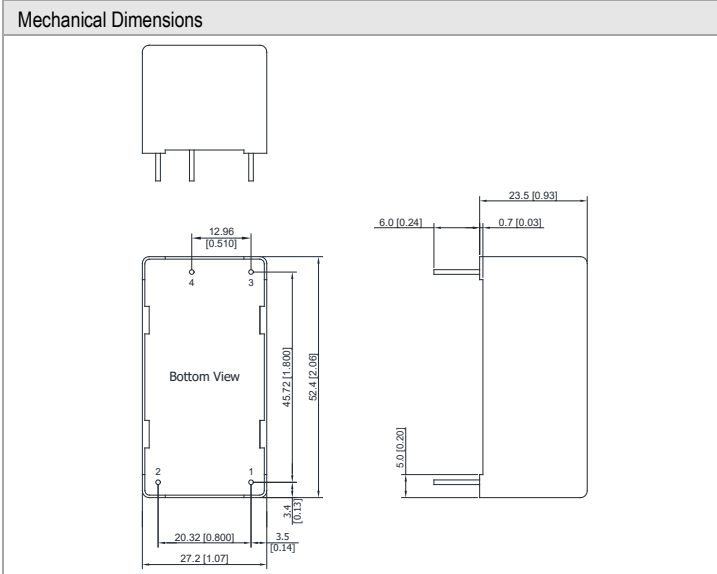

Pin Connections

Pin	Function	Diameter mm (inches)
1	AC(N)	∅ 1.0 [0.04]
2	AC(L)	∅ 1.0 [0.04]
3	+Vout	∅ 1.0 [0.04]
4	-Vout	∅ 1.0 [0.04]

- ▶ All dimensions in mm (inches)
- ▶ Tolerance: ±0.5 (±0.02)
- ▶ Pin pitch tolerance: ±0.25 (±0.01)
- ▶ Pin diameter tolerance: X.X±0.1 (X.XX±0.004)

Physical Characteristics

Case Size	: 52.4x27.2x23.5mm (2.06x1.07x0.93 inches)
Case Material	: Plastic resin (flammability to UL 94V-0 rated)
Pin Material	: Copper Alloy
Weight	: 51g

Package Specifications Chassis Mounting with screw terminal (order code suffix C)

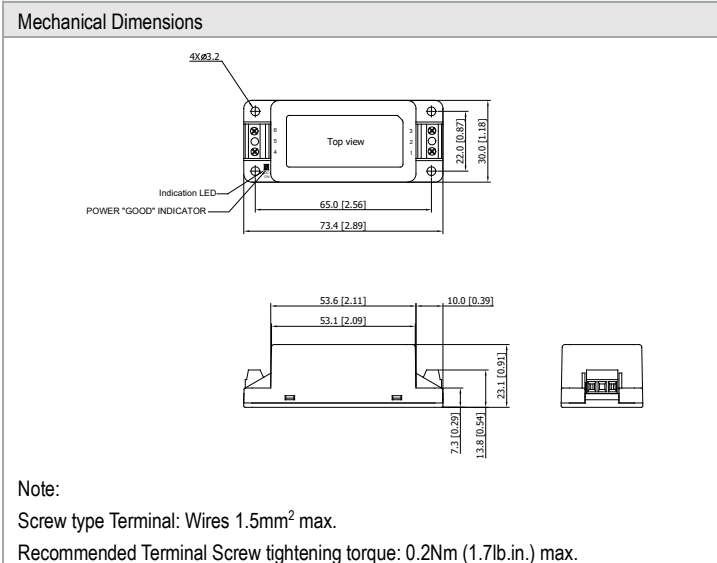

Pin Connections

Pin	Function
1	AC(N)
2	No Pin
3	AC(L)
4	+Vout
5	No Pin
6	-Vout

- ▶ All dimensions in mm (inches)
- ▶ Tolerance: ±0.5 (±0.02)

Physical Characteristics

Case Size	: 73.4x30.0x23.1mm (2.89x1.18x0.91 inches)
Case Material	: Plastic resin (flammability to UL 94V-0 rated)
Weight	: 56g

Package Specifications for screw terminal with DIN Rail Mounting (order code suffix AC-DIN-06)

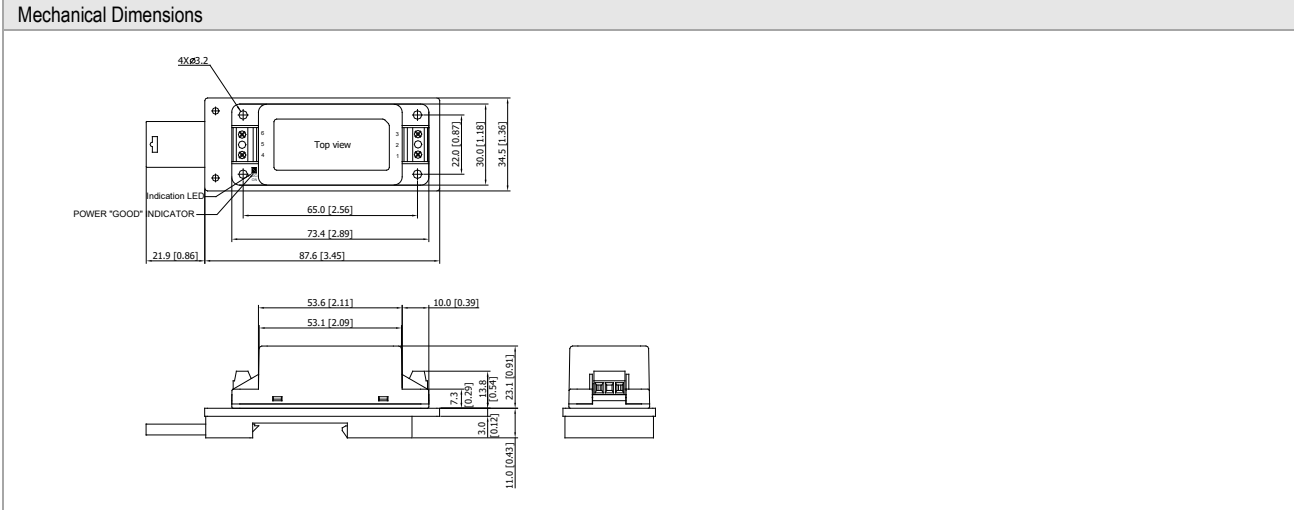

Physical Characteristics

Case Size	: 73.4x30.0x23.1mm (2.89x1.18x0.91 inches)
Case Material	: Plastic resin (flammability to UL 94V-0 rated)
Weight	: 101g

Screw terminal with DIN Rail Mounting

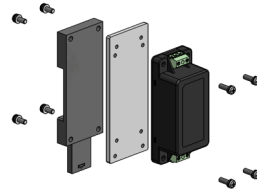
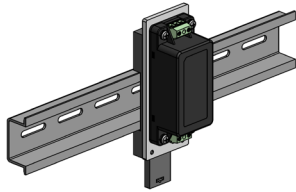

Package Specifications Chassis Mounting with JST connection (order code suffix CD)

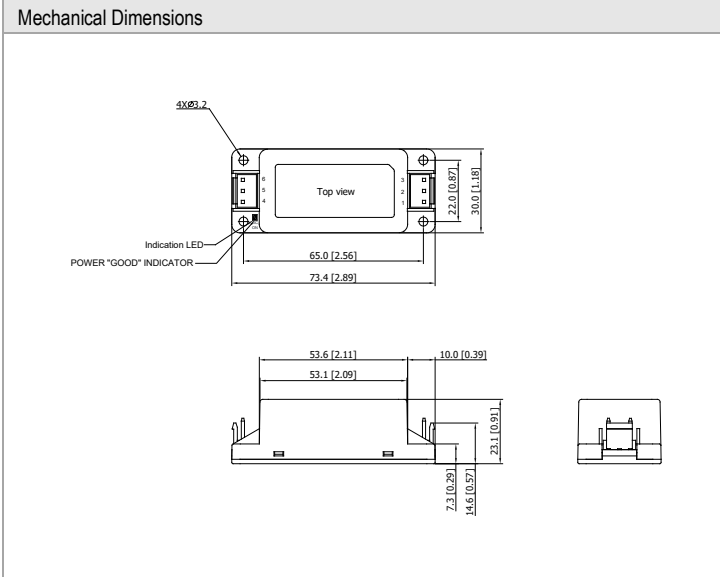

Pin Connections

Pin	Function
1	AC(N)
2	No Pin
3	AC(L)
4	No Pin
5	+Vout
6	-Vout

Input (pin 1, pin 3): JST Connector
 mates with JST crimp contacts: SVH-41T-P1.1
 terminal housing: VAR-2
 Output (pin 5, pin 6): JST Connector
 mates with JST crimp contacts: SVH-41T-P1.1
 terminal housing: VHR-3

- ▶ All dimensions in mm (inches)
- ▶ Tolerance: ± 0.5 (± 0.02)

Physical Characteristics

Case Size	: 73.4x30.0x23.1mm (2.89x1.18x0.91 inches)
Case Material	: Plastic resin (flammability to UL 94V-0 rated)
Weight	: 56g

Package Specifications for JST connection with DIN Rail Mounting (order code suffix AC-DIN-06)

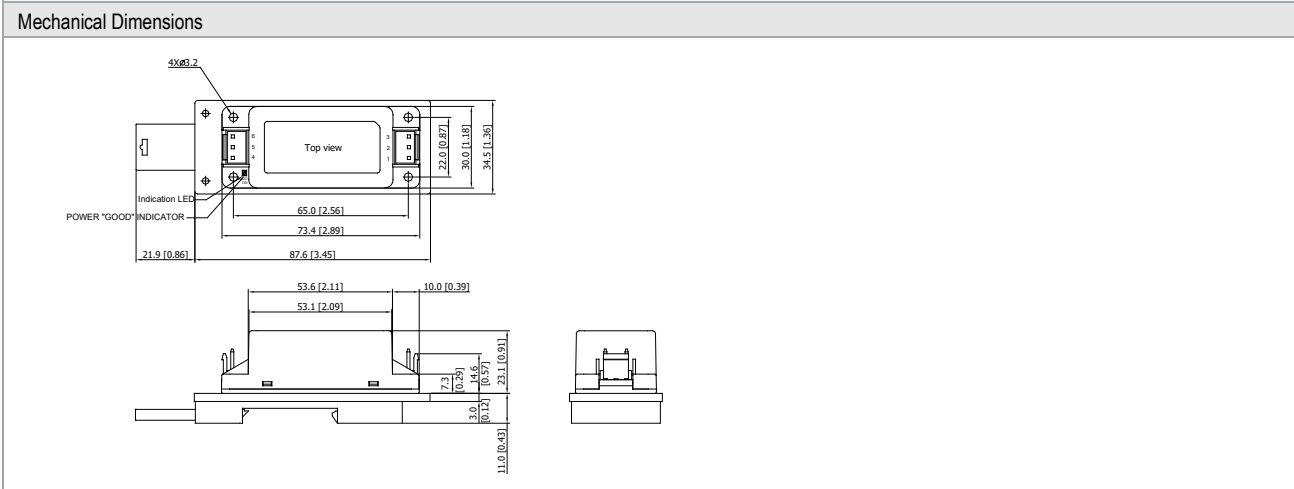

Physical Characteristics

Case Size	: 73.4x30.0x23.1mm (2.89x1.18x0.91 inches)
Case Material	: Plastic resin (flammability to UL 94V-0 rated)
Weight	: 101g

JST connection with DIN Rail Mounting

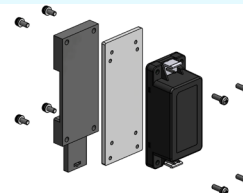
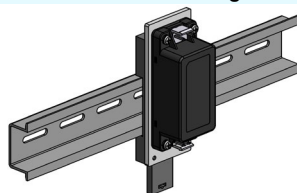

Recommended Pad Layout

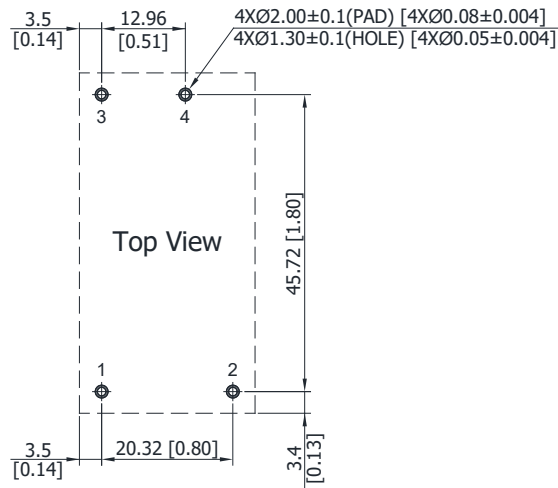

Packaging Information

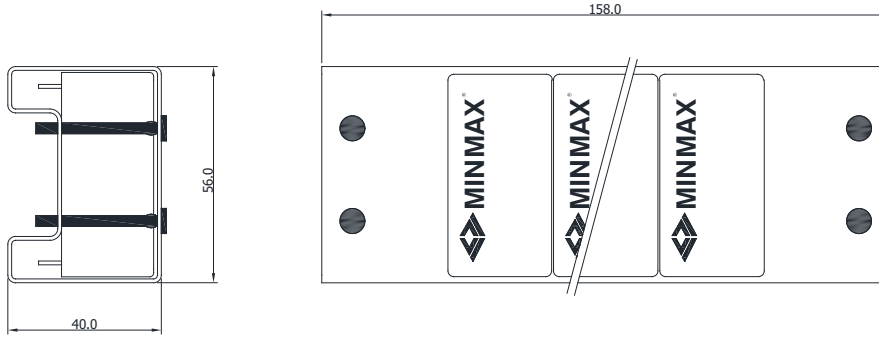

Unit: mm
AMF-15 PCB Mounting 5 PCS per TUBE

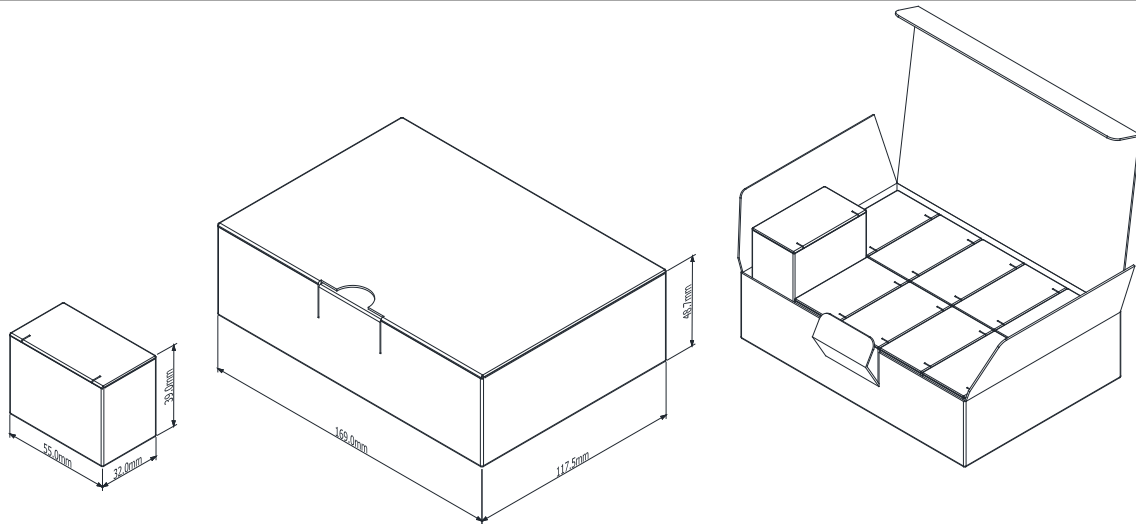

Unit: mm
AMF-15 PCB Mounting 10 PCS per Box

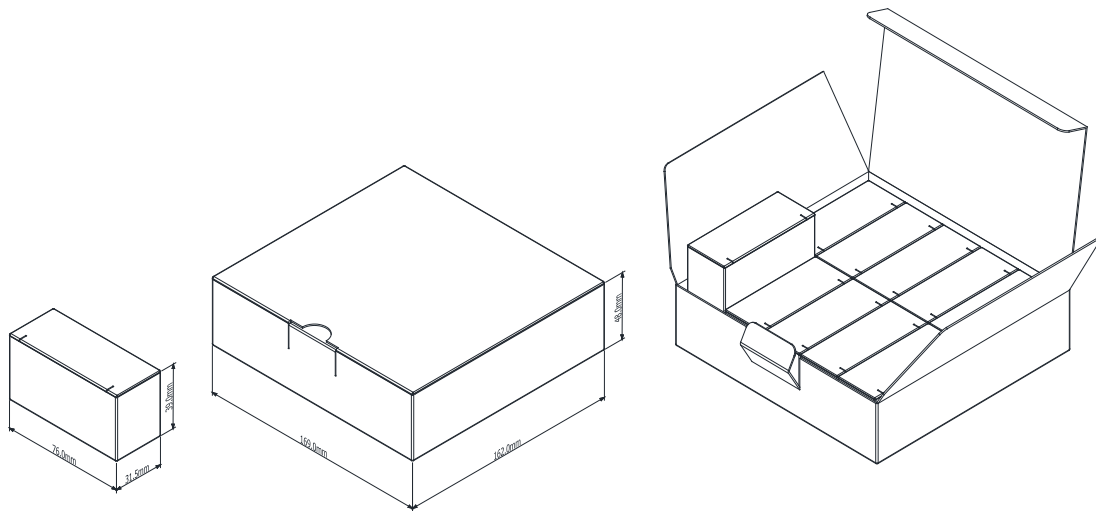

Unit: mm
AMF-15 Chassis Mounting 10 PCS per Box

Wave Soldering Considerations

Lead free wave solder profile

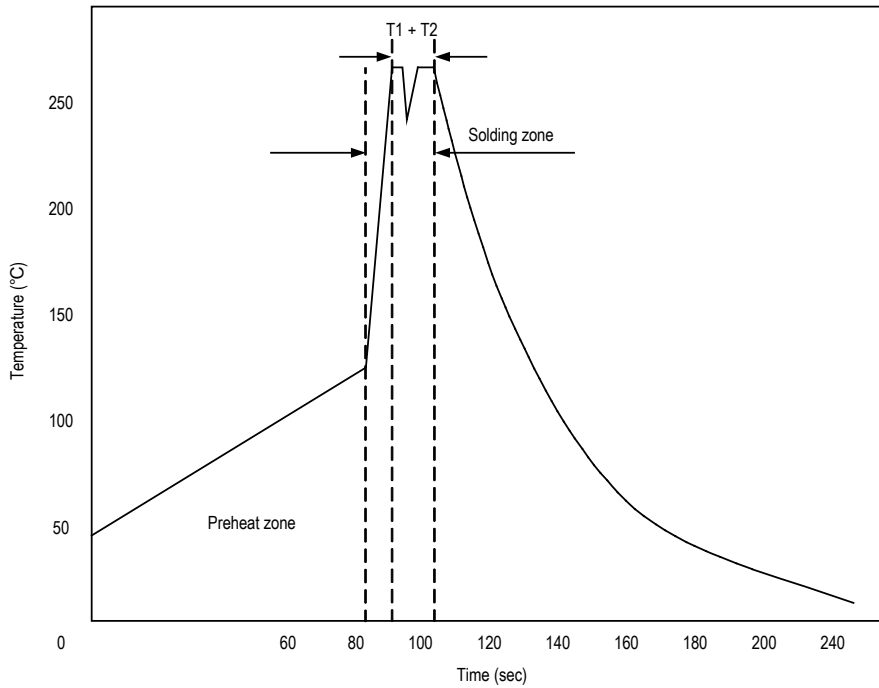

Zone	Reference Parameter
Preheat	Rise temp. speed : 3°C/sec max.
zone	Preheat temp. : 100~130°C
Actual	Peak temp. : 250~260°C
heating	Peak time(T1+T2) : 4~6 sec

Hand Welding Parameter

Reference Solder: Sn-Ag-Cu : Sn-Cu : Sn-Ag

Hand Welding: Soldering iron : Power 60W

Welding Time: 2~4 sec

Temp.: 380~400°C

Part Number Structure					
AMF	-	15	S	051	C
		Output Power 15 Watt	Output Quantity S: Single	Output Voltage 051: 5.1 VDC 12: 12 VDC 15: 15 VDC 24: 24 VDC 48: 48 VDC	Package Type N/A: PCB Mounting C: Chassis Mounting with screw terminal CD: Chassis Mounting with JST connection

MTBF and Reliability		
The MTBF of AMF-15 series of AC-DC Power Module has been calculated using MIL-HDBK 217F NOTICE2, Operating Temperature 25°C, Ground Benign.		
Model	MTBF	Unit
AMF-15S051	514,887	Hours
AMF-15S12	458,989	
AMF-15S15	584,181	
AMF-15S24	550,869	
AMF-15S48	618,456	
AMF-15S051C	511,226	
AMF-15S12C	456,090	
AMF-15S15C	579,494	
AMF-15S24C	546,699	
AMF-15S48C	613,206	
AMF-15S051CD	511,226	
AMF-15S12CD	456,090	
AMF-15S15CD	579,494	
AMF-15S24CD	546,699	
AMF-15S48CD	613,206	