

FEATURES

- ▶ Ultra Compact Size 2.52x1.77x0.94 "
- ▶ Fully Encapsulated Plastic Case for PCB, Chassis and DIN-Rail Mounting Version
- ▶ Universal Input 85-264VAC, 90-370VDC, 47-440Hz
- ▶ I/O Isolation 3000VAC with Reinforced Insulation
- ▶ No Min. Load Requirement & Low no-load power consumption
- ▶ Operating Ambient Temp. Range -40°C to +70°C
- ▶ Overload/Voltage and Short Circuit Protection
- ▶ EMI Emission EN55014-1/55032 Class B Approved
- ▶ EMS Immunity EN61000-4-2,3,4,5,6,8,11 Approved
- ▶ Safety Approval to UL/cUL/IEC/EN 62368-1, IEC/EN 60335-1 & CE Marking



PRODUCT OVERVIEW

The MINMAX AMF-30 series is a new generation of fully encapsulated AC-DC power supply modules with ultra-compact size for higher power density and space saving.

The product features universal AC input 85-264VAC and wider DC input 90-370VDC, regulated output voltages 5.1, 12, 15, 24, 48VDC ; I/O Isolation 3000VAC with Reinforced Insulation ; EMI emission EN55014-1/32 Class B and EMS immunity EN 61000-4 standards approved ; no min. load requirement and low no-load power consumption; abnormal protection mechanism with output overload, short circuit and overvoltage protections.

The AMF-30 series equips with PCB, Chassis and DIN-Rail Mounting Version for flexible installation and comply with UL/IEC/EN 62368-1 & IEC/EN 60335-1 for safety usage. It provides a cost effective solution especially for space critical applications in industrial and household electronic equipment.

Model Selection Guide

Model Number	Output Voltage	Output Power	Output Current	Input Current	Max. capacitive Load	Efficiency (typ.)
				115VAC, 60Hz		(typ.)
				@Max. Load		@Max. Load
	VDC	W	A	mA(typ.)	μF	%
AMF-30S051	5.1	25.5	5	486	6800	86
AMF-30S12	12	30	2.5	570	1200	88
AMF-30S15	15	30	2	570	680	88
AMF-30S24	24	30	1.25	570	560	88
AMF-30S48	48	30	0.625	570	100	88

Input Specifications

Parameter	Conditions / Model		Min.	Typ.	Max.	Unit
AC Input Voltage Range	ALL Models		85	---	264	VAC
AC Input Frequency Range			47	---	440	Hz
DC Input Voltage Range			90	---	370	VDC
No-Load Power Consumption	115VAC	PCB Mounting	---	---	100	mW
	230VAC		---	---	200	mW
	115VAC	Chassis Mounting	---	---	150	mW
	230VAC		---	---	250	mW
Inrush Current	115VAC	Cold Start at 25°C	---	---	30	A
	230VAC		---	---	60	A

Output Specifications

Parameter	Conditions / Model	Min.	Typ.	Max.	Unit	
Output Voltage Accuracy		---	±1.0	±2.0	%	
Line Regulation	Vin=Min. to Max. @Full Load	---	---	±0.5	%	
Load Regulation	Io=0% to 100%	---	---	±1.0	%	
Ripple & Noise	0-20 MHz Bandwidth	5.1VDC Output Model	---	---	1.8	%V _{PP} of Vo
		Other Output Models	---	---	1.0	%V _{PP} of Vo
Minimum Load	No minimum Load Requirement					
Over Voltage Protection	Zener diode clamp	---	125	---	% of Vo	
Temperature Coefficient		---	±0.01	±0.02	%/°C	
Overshoot		---	---	5	% Vout	
Over Load Protection	auto-recovery	110	---	---	%Inom.	
	(long term overload condition may cause damage)					
Short Circuit Protection	Hiccup mode, Automatic Recovery					

General Specifications

Parameter	Conditions	Min.	Typ.	Max.	Unit
I/O Isolation Voltage	Input to Output, 60 Seconds	3000	---	---	VAC
I/O Isolation Resistance	500 VDC	10	---	---	GΩ
Switching Frequency		---	65	---	kHz
Start-up Time		---	---	1	s
Hold-up Time	115VAC, 60Hz	10	---	---	ms
	230VAC, 50Hz	20	---	---	ms
MTBF (calculated)	MIL-HDBK-217F@25°C, Ground Benign	414,725	---	---	Hours
Safety Approvals	UL/cUL 62368-1 recognition(UL certificate), IEC/EN 62368-1(CB-report)				
	IEC/EN 60335-1, 61558-1, 61558-2-16 recognition(CB-report)				

EMC Specifications

Parameter	Standards & Level			Performance
General	Compliance with EN 61204-3 Switch mode power supplies			
EMI	Conduction	EN 55014-1, EN 55032	Without external components	Class B
	Radiation			
EMS	EN 55014-2, EN 55024, EN 55035			
	ESD	Direct discharge	Indirect discharge HCP & VCP	
		EN61000-4-2 air ± 8kV	Contact ± 6kV	
	Radiated immunity	EN 61000-4-3 10V/m		
	Fast transient	EN 61000-4-4 ±2kV		
	Surge	EN 61000-4-5 ±1kV		
	Conducted immunity	EN 61000-4-6 10Vrms		
	PFMF	EN 61000-4-8 30A/m		
Dips	EN 61000-4-11 30% 10ms			
Interruptions	EN 61000-4-11 >95% 5000ms			

Environmental Specifications

Parameter	Min.	Typ.	Max.	Unit
Operating Ambient Temperature Range (See Power Derating Curve)	-40	---	+70	°C
Storage Temperature Range	-40	---	+85	°C
Humidity (non condensing)	---	---	95	% rel. H
Lead Temperature (1.5mm from case for 10Sec.)	---	---	260	°C

Power Derating Curve

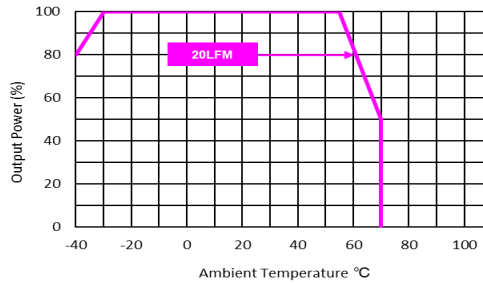

Notes

- 1 All Specifications typical at Ta=+25°C, resistive load, 115VAC, 60Hz input voltage and after warm-up time rated output current unless otherwise noted.
- 2 We recommend to protect the converter by a slow blow fuse in the input supply line.
- 3 Other input and output voltage may be available, please contact MINMAX.
- 4 Specifications are subject to change without notice

Package Specifications PCB Mounting

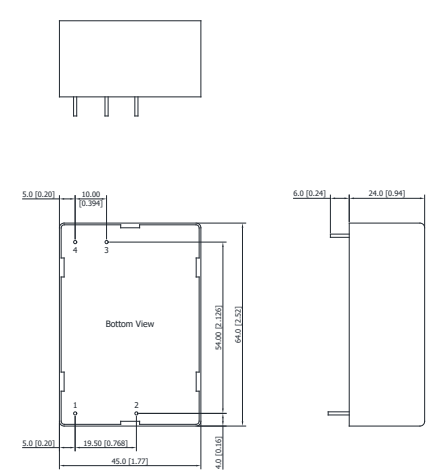
Mechanical Dimensions		Pin Connections																
		<table border="1"> <thead> <tr> <th>Pin</th> <th>Function</th> <th>Diameter mm (inches)</th> </tr> </thead> <tbody> <tr> <td>1</td> <td>AC(L) – AC Line</td> <td>∅ 1.0 [0.04]</td> </tr> <tr> <td>2</td> <td>AC(N) – AC Neutral</td> <td>∅ 1.0 [0.04]</td> </tr> <tr> <td>3</td> <td>+Vout</td> <td>∅ 1.0 [0.04]</td> </tr> <tr> <td>4</td> <td>-Vout</td> <td>∅ 1.0 [0.04]</td> </tr> </tbody> </table>	Pin	Function	Diameter mm (inches)	1	AC(L) – AC Line	∅ 1.0 [0.04]	2	AC(N) – AC Neutral	∅ 1.0 [0.04]	3	+Vout	∅ 1.0 [0.04]	4	-Vout	∅ 1.0 [0.04]	<ul style="list-style-type: none"> ▶ All dimensions in mm (inches) ▶ Tolerance: ±0.5 (±0.02) ▶ Pin pitch tolerance: ±0.25 (0.01) ▶ Pin diameter tolerance: X.X±0.1 (X.XX±0.004)
Pin	Function	Diameter mm (inches)																
1	AC(L) – AC Line	∅ 1.0 [0.04]																
2	AC(N) – AC Neutral	∅ 1.0 [0.04]																
3	+Vout	∅ 1.0 [0.04]																
4	-Vout	∅ 1.0 [0.04]																

Physical Characteristics

Case Size	: 64.0x45.0x24.0mm (2.52x1.77x0.94 inches)
Case Material	: Plastic resin (flammability to UL 94V-0 rated)
Pin Material	: Copper Alloy
Weight	: 96g

Package Specifications Chassis Mounting with screw terminal (order code suffix C)

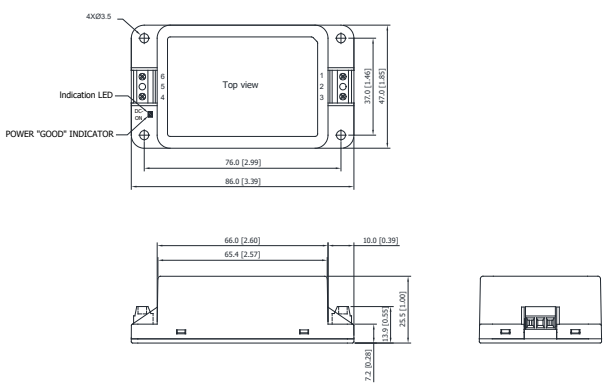
Mechanical Dimensions		Pin Connections	
		Pin	Function
		1	AC(L) – AC Line
		2	No Pin
		3	AC(N) – AC Neutral
		4	+Vout
		5	No Pin
6	-Vout		
<p>Note:</p> <p>Screw type Terminal: Wires 1.5mm² max. Recommended Terminal Screw tightening torque: 0.2Nm (1.7lb.in.) max.</p>		<p>▶ All dimensions in mm (inches) ▶ Tolerance: ±0.5 (±0.02)</p>	

Physical Characteristics

Case Size	: 86.0x47.0x25.5mm (3.39x1.85x1.00 inches)
Case Material	: Plastic resin (flammability to UL 94V-0 rated)
Weight	: 116g

Package Specifications for screw terminal with DIN Rail Mounting (order code suffix AC-DIN-07)

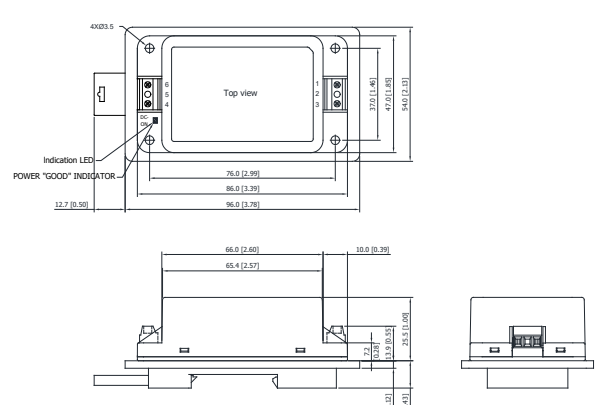
Mechanical Dimensions	
	

Physical Characteristics

Case Size	: 86.0x47.0x25.5mm (3.39x1.85x1.00 inches)
Case Material	: Plastic resin (flammability to UL 94V-0 rated)
Weight	: 180g

Screw terminal with DIN Rail Mounting



Package Specifications Chassis Mounting with JST connection (order code suffix CD)

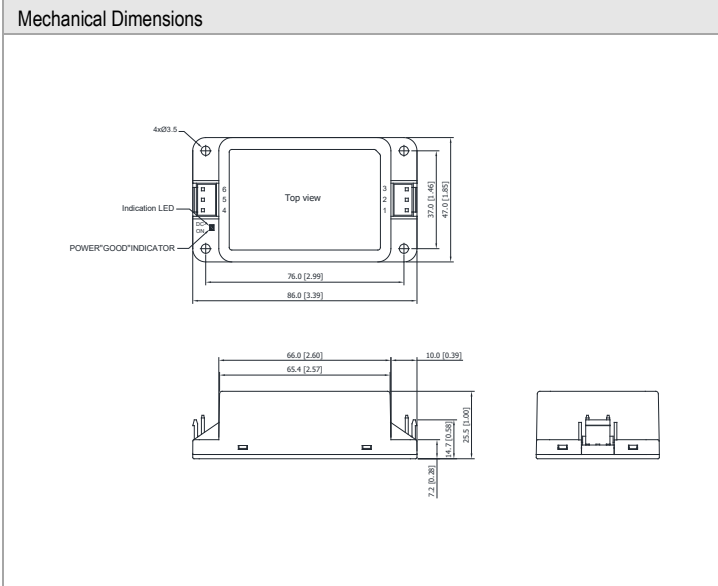

Pin Connections

Pin	Function
1	AC(N) – AC Neutral
2	No Pin
3	AC(L) – AC Line
4	No Pin
5	+Vout
6	-Vout

Input (pin 1, pin 3): JST Connector
mates with JST crimp contacts: SVH-41T-P1.1
terminal housing: VAR-2
Output (pin 5, pin 6): JST Connector
mates with JST crimp contacts: SVH-41T-P1.1
terminal housing: VHR-3

- ▶ All dimensions in mm (inches)
- ▶ Tolerance: ± 0.5 (± 0.02)

Physical Characteristics

Case Size	: 86.0x47.0x25.5mm (3.39x1.85x1.00 inches)
Case Material	: Plastic resin (flammability to UL 94V-0 rated)
Weight	: 115g

Package Specifications for JST connection with DIN Rail Mounting (order code suffix AC-DIN-07)

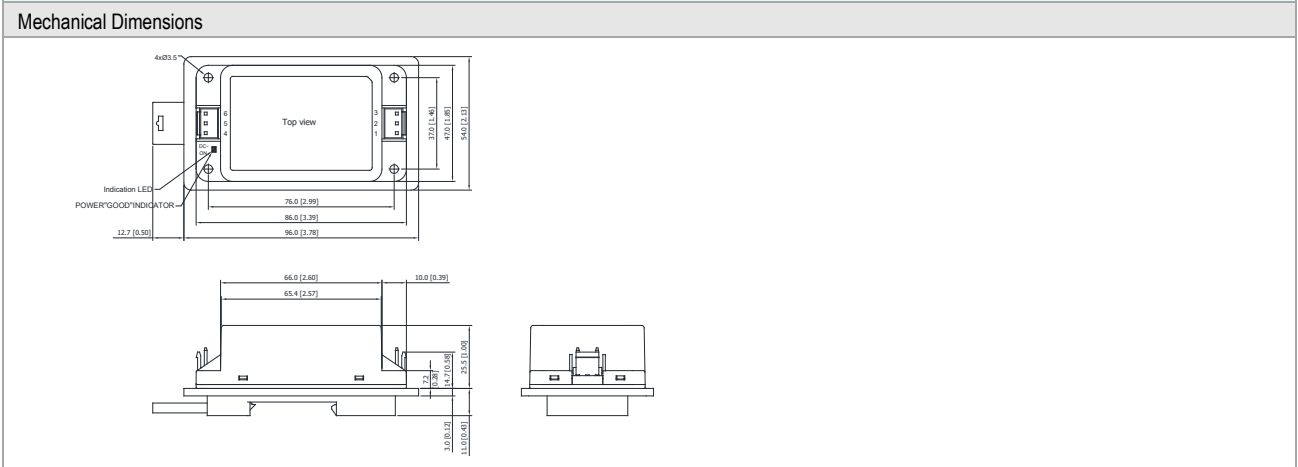

Physical Characteristics

Case Size	: 86.0x47.0x25.5mm (3.39x1.85x1.00 inches)
Case Material	: Plastic resin (flammability to UL 94V-0 rated)
Weight	: 179g

JST connection with DIN Rail Mounting

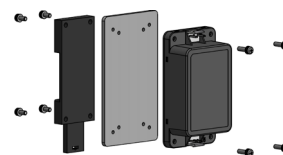
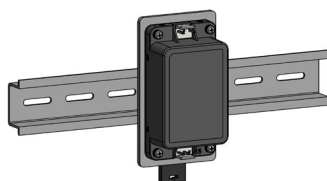

Order Code Table					
PCB Mounting	Chassis Mounting with screw terminal		Chassis Mounting with JST connection		DIN Rail Kit
	Power module only	Power module with Din Rail Kit	Power module only	Power module with Din Rail Kit	
AMF-30S051	AMF-30S051C	AMF-30S051C- AC-DIN-07	AMF-30S051CD	AMF-30S051CD- AC-DIN-07	AC-DIN-07
AMF-30S12	AMF-30S12C	AMF-30S12C- AC-DIN-07	AMF-30S12CD	AMF-30S12CD- AC-DIN-07	AC-DIN-07
AMF-30S15	AMF-30S15C	AMF-30S15C- AC-DIN-07	AMF-30S15CD	AMF-30S15CD- AC-DIN-07	AC-DIN-07
AMF-30S24	AMF-30S24C	AMF-30S24C- AC-DIN-07	AMF-30S24CD	AMF-30S24CD- AC-DIN-07	AC-DIN-07
AMF-30S48	AMF-30S48C	AMF-30S48C- AC-DIN-07	AMF-30S48CD	AMF-30S48CD- AC-DIN-07	AC-DIN-07