

FEATURES

- ▶ Fully Encapsulated Plastic Case for Chassis and DIN-Rail Mounting Version
- ▶ 80-160VDC Wide Input Voltage Range
- ▶ Fully Regulated Output Voltage
- ▶ High Efficiency up to 88%
- ▶ I/O Isolation 3000VAC with Reinforced Insulation, rated for 1000Vrms Working Voltage
- ▶ Operating Ambient Temp. Range -40°C to +94.5°C
- ▶ No Min. Load Requirement
- ▶ Very Low No Load Power Consumption
- ▶ Under-voltage, Overload/Voltage and Short Circuit Protection
- ▶ Remote On/Off Control
- ▶ EMI Emission EN 55032 Class A Approved
- ▶ EMC Immunity EN 61000-4-2,3,4,5,6,8 Approved
- ▶ UL/cUL/IEC/EN 62368-1 Safety Approval & CE Marking

PRODUCT OVERVIEW

The MINMAX MOA20C series is the latest 20Watt isolated DC-DC power module generation with 9 fixed output voltage models: 5 / 5.1 / 12 / 15 / 24 / 48 / ±12 / ±15 / ±24VDC. The wide input range from 80VDC to 160VDC is specifically for electricity and renewable energy field applications within the usage of terminal strip connectors in chassis and DIN-Rail package.

The key performances are : 3000VAC I/O Isolation, reinforced insulation, high efficiency, wide operating ambient temp. range -40°C to +94.5°C, no min. load, low no-load power consumption, remote on/off, built-in EMI emission EN 55032 Class A, UVLO, OVP, and SCP. The MOA20C series certifies in safety UL/cUL/IEC/EN 62368-1 with CB report and CE marking and offers a solution for eliminating components of a power board.

Model Selection Guide

Model Number	Input Voltage (Range) VDC	Output Voltage VDC	Output Current Max. mA	Input Current		Over Voltage Protection VDC	Max. capacitive Load µF	Efficiency (typ.) %
				@ Max. Load mA(typ.)	@ No Load mA(typ.)			
MOA20-110S05C	110 (80 ~ 160)	5	4000	209	10	6.2	6800	87
MOA20-110S051C		5.1	4000	213		6.2	6800	87
MOA20-110S12C		12	1670	207		15	1200	88
MOA20-110S15C		15	1340	208		18	750	88
MOA20-110S24C		24	830	206		30	300	88
MOA20-110S48C		48	420	208		60	75	86
MOA20-110D12C		±12	±830	208		±15	380#	87
MOA20-110D15C		±15	±670	210		±18	380#	87
MOA20-110D24C		±24	±420	211		±30	150#	87

For each output

Input Specifications

Parameter	Conditions / Model	Min.	Typ.	Max.	Unit
Input Surge Voltage (100 ms max.)		-0.7	---	170	VDC
Start-Up Threshold Voltage		---	---	80	
Under Voltage Shutdown		65	70	---	
Start Up Time (Power On)	Nominal Vin and Constant Resistive Load	---	30	60	ms
Input Filter	All Models	Internal Pi Type			

Remote On/Off Control					
Parameter	Conditions	Min.	Typ.	Max.	Unit
Converter On	3.5V ~ 12V or Open Circuit				
Converter Off	0V ~ 1.2V or Short Circuit				
Control Input Current (On)	Vctrl = 5.0V	---	---	0.5	mA
Control Input Current (Off)	Vctrl = 0V	---	---	-0.5	mA
Control Common	Referenced to Negative Input				
Standby Input Current	Nominal Vin	---	3	---	mA

Output Specifications						
Parameter	Conditions / Model	Min.	Typ.	Max.	Unit	
Output Voltage Setting Accuracy		---	±1.0	±2.0	%Vnom.	
Output Voltage Balance	Dual Output, Balanced Loads	---	---	±2.0	%	
Line Regulation	Vin=Min. to Max. @Full Load	---	±0.5	±1.0	%	
Load Regulation	Io=0% to 100%	---	±0.5	±1.0	%	
Load Cross Regulation (Dual Output Models)	Asymmetrical Load 25/100% Full Load	---	---	±5.0	%	
Minimum Load	No minimum Load Requirement					
Ripple & Noise	0-20MHz Bandwidth	5V & 5.1V Output Models	---	---	100	mV _{P-P}
		±24V & 48V Output Models	---	---	200	mV _{P-P}
		Other Output Models	---	---	150	mV _{P-P}
Transient Recovery Time	25% Load Step Change ₍₂₎	---	250	---	μsec	
Transient Response Deviation		---	±3	±5	%	
Temperature Coefficient		---	---	±0.02	%/°C	
Over Load Protection	Hiccup	---	150	180	%	
Short Circuit Protection	Continuous, Automatic Recovery (Hiccup Mode 0.5Hz typ.)					

General Specifications					
Parameter	Conditions / Model	Min.	Typ.	Max.	Unit
I/O Isolation Voltage	60 Seconds Reinforced insulation, rated for 1000Vrms working voltage	3000	---	---	VAC
I/O Isolation Resistance	500 VDC	1000	---	---	MΩ
I/O Isolation Capacitance	100kHz, 1V	---	---	2200	pF
Switching Frequency	5V & 5.1V Output Models	187	220	253	kHz
	Other Output Models	238	280	322	kHz
MTBF (calculated)	MIL-HDBK-217F@25°C, Ground Benign	696,909	---	---	Hours
Safety Approvals	UL/cUL 62368-1 recognition(UL certificate), IEC/EN 62368-1 & 60950-1(CB report)				

EMC Specifications				
Parameter	Standards & Level			Performance
EMI	Conduction	EN 55032	Without external components	Class A
	Radiation			
EMS	EN 55035			
	ESD	Direct discharge	Indirect discharge HCP & VCP	
		EN 61000-4-2 Air ± 8kV	Contact ±6kV	
	Radiated immunity	EN 61000-4-3 10V/m		
	Fast transient	EN 61000-4-4 ±2kV		
	Surge	EN 61000-4-5 ±2kV		
	Conducted immunity	EN 61000-4-6 10Vrms		
PFMF	EN 61000-4-8 100A/m			

Environmental Specifications

Parameter	Min.	Max.	Unit
Operating Ambient Temperature Range (See Power Derating Curve)	-40	+94.5	°C
Case Temperature	---	+105	°C
Storage Temperature Range	-50	+125	°C
Humidity (non condensing)	---	95	% rel. H

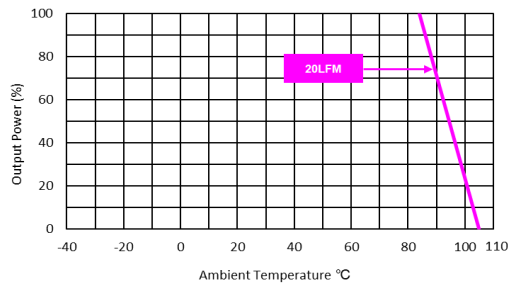
Power Derating Curve

Notes

- 1 Specifications typical at Ta=+25°C, resistive load, nominal input voltage and rated output current unless otherwise noted.
- 2 Transient recovery time is measured to within 1% error band for a step change in output load of 75% to 100%.
- 3 We recommend to protect the converter by a slow blow fuse in the input supply line.
- 4 Other input and output voltage may be available, please contact MINMAX.
- 5 Specifications are subject to change without notice.

Package Specifications Chassis Mounting

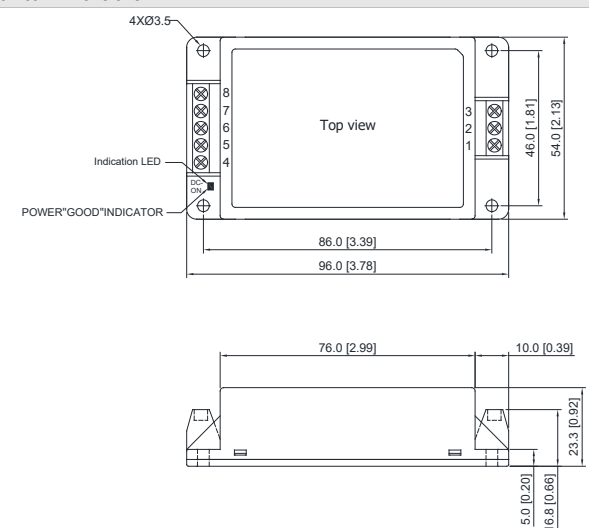
Mechanical Dimensions



Note:
Screw type Terminal: Wires 1.5mm² max.
Recommended Terminal Screw tightening torque: 0.5Nm (3.5lb.in.) max.

Connections

Pin	Single Output	Dual Output
1	Remote On/Off	Remote On/Off
2	-Vin	-Vin
3	+Vin	+Vin
4	NC	NC
5	-Vout	-Vout
6	NC	Common
7	+Vout	+Vout
8	NC	NC

NC: No Connection

- ▶ All dimensions in mm (inches)
- ▶ Tolerance: ±0.5 (±0.02)

Physical Characteristics

Case Size	: 96.0x54.0x23.3mm (3.78x2.13x0.92 inches)
Case Material	: Plastic resin (flammability to UL 94V-0 rated)
Weight	: 107g

Package Specifications with DIN Rail Mounting Bracket (order code AC-DIN-01)

Mechanical Dimensions

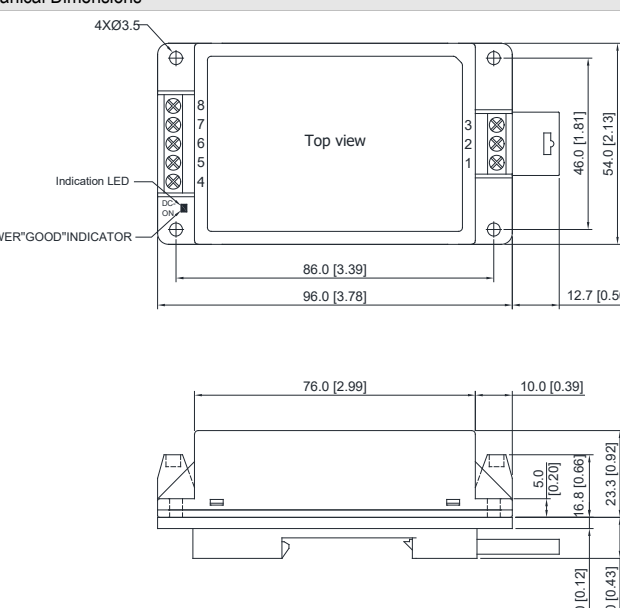
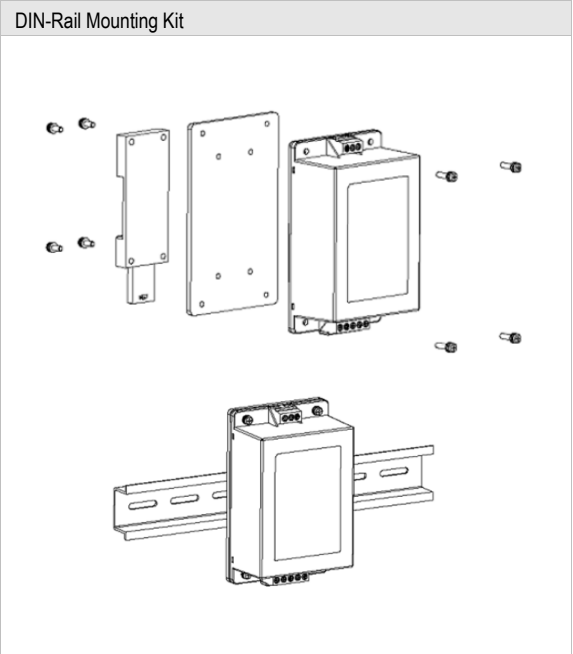
Physical Characteristics

Case Size	: 96.0x54.0x23.3mm (3.78x2.13x0.92 inches)
Case Material	: Plastic resin (flammability to UL 94V-0 rated)
Weight	: 166g

Order Code Table		
Standard	DIN Rail	Converter with DIN Rail Mounting
MOA20-110S05C	AC-DIN-01	MOA20-110S05C-DIN01
MOA20-110S051C	AC-DIN-01	MOA20-110S051C-DIN01
MOA20-110S12C	AC-DIN-01	MOA20-110S12C-DIN01
MOA20-110S15C	AC-DIN-01	MOA20-110S15C-DIN01
MOA20-110S24C	AC-DIN-01	MOA20-110S24C-DIN01
MOA20-110S48C	AC-DIN-01	MOA20-110S48C-DIN01
MOA20-110D12C	AC-DIN-01	MOA20-110D12C-DIN01
MOA20-110D15C	AC-DIN-01	MOA20-110D15C-DIN01
MOA20-110D24C	AC-DIN-01	MOA20-110D24C-DIN01

Test Setup

Peak-to-Peak Output Noise Measurement Test

Scope measurement should be made by using a BNC socket, measurement bandwidth is 0-20 MHz. Position the load between 50 mm and 75 mm from the DC-DC Converter.

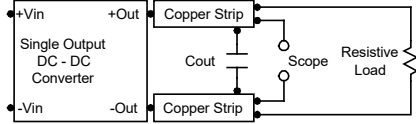

Technical Notes

Remote On/Off

Positive logic remote on/off turns the module on during a logic high voltage on the remote on/off pin, and off during a logic low. To turn the power module on and off, the user must supply a switch to control the voltage between the on/off terminal and the -Vin terminal. The switch can be an open collector or equivalent. A logic low is 0V to 1.2V. A logic high is 3.5V to 12V. The maximum sink current at the on/off terminal (Pin 1) during a logic low is -100 μ A.

Overload Protection

To provide hiccup mode protection in a fault (output overload) condition, the unit is equipped with internal current limiting circuitry and can endure overload for an unlimited duration.

Overvoltage Protection

The output overvoltage clamp consists of control circuitry, which is independent of the primary regulation loop, that monitors the voltage on the output terminals. The control loop of the clamp has a higher voltage set point than the primary loop. This provides a redundant voltage control that reduces the risk of output overvoltage. The OVP level can be found in the output data.

Input Source Impedance

The power module should be connected to a low ac-impedance input source. Highly inductive source impedances can affect the stability of the power module. In applications where power is supplied over long lines and output loading is high, it may be necessary to use a capacitor at the input to ensure startup. Capacitor mounted close to the power module helps ensure stability of the unit, it is recommended to use a good quality low Equivalent Series Resistance (ESR < 1.0 Ω at 100 kHz) capacitor of a 10 μ F for the 110V devices.

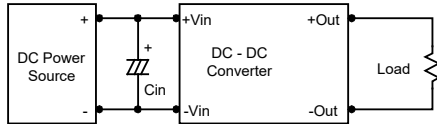

Output Ripple Reduction

A good quality low ESR capacitor placed as close as practicable across the load will give the best ripple and noise performance. To reduce output ripple, it is recommended to use 4.7 μ F capacitors at the output.

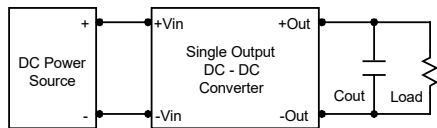

Maximum Capacitive Load

The MOA20C series has limitation of maximum connected capacitance at the output. The power module may be operated in current limiting mode during start-up, affecting the ramp-up and the startup time. The maximum capacitance can be found in the data sheet.

Thermal Considerations

Many conditions affect the thermal performance of the power module, such as orientation, airflow over the module and board spacing. To avoid exceeding the maximum temperature rating of the components inside the power module, the case temperature must be kept below 105°C. The derating curves are determined from measurements obtained in a test setup.

