



MINMAX[®]

MSCWI02 Series

Electric Characteristic Note

MSCWI02 Series EC Note

DC-DC CONVERTER 2W, SMD Package

Features

- ▶ Very Compact SMD Package
- ▶ Ultra-wide 4:1 Input Voltage Range
- ▶ Fully Regulated Output Voltage
- ▶ I/O Isolation 1500VDC
- ▶ Operating Ambient Temp. Range -40°C to +80°C
- ▶ No Min. Load Requirement
- ▶ Under-voltage, Overload and Short Circuit Protection
- ▶ Remote On/Off Control
- ▶ EMI Emission EN55032 Class A Approved
- ▶ Cleaning-washable Process Available(option)
- ▶ Qualified for Lead-free Reflow Solder Process According to IPC/JEDEC J-STD-020D.1
- ▶ Tape & Reel Package Available
- ▶ UL/cUL/IEC/EN 62368-1(60950-1) Safety Approval & CE Marking



Applications

- ▶ Distributed power architectures
- ▶ Workstations
- ▶ Computer equipment
- ▶ Communications equipment

Product Overview

The MINMAX MSCWI02 series is a range of isolated 2W DC-DC converter modules-features ultra-wide input voltage ranges and fully regulated output voltage. The product come in a SMD package with very small footprint occupying only 0.3 in² (0.2 cm²) of PCB space. The converters are qualified to withstand lead free reflow processes according to IPC J-STD-020D.1 standard. High efficiency allows operating temperatures range of -40°C to 80°C. Further features include under-voltage protection, overload protection, short circuit protection, no min. load requirement and remote ON/OFF. These DC-DC converters offer the best solution for many space critical applications in battery-powered equipment, instrumentation, distributed power architectures in communication and industrial electronics.

Table of contents

Model Selection Guide	P2	Test Setup.....	P24
Input Specifications.....	P2	Technical Notes	P24
Remote On/Off Specifications	P2	Remote On/Off Implementation.....	P25
Output Specifications.....	P3	Packaging Information for Tube	P25
General Specifications.....	P3	Packaging Information for Tape & Reel.....	P26
EMC Specifications.....	P3	Soldering and Reflow Considerations	P27
Environmental Specifications	P4	Part Number Structure	P28
Characteristic Curves	P5	MTBF and Reliability	P28
Package Specifications	P23		

Model Selection Guide

Model Number	Input Voltage (Range)	Output Voltage	Output Current	Input Current		Max. capacitive Load	Efficiency (typ.)
				Max.	@No Load		
	VDC	VDC	mA	@Max. Load mA(typ.)	@No Load mA(typ.)	μF	@Max. Load %
MSCWI02-05S05	5 (4.5 ~ 12)	5	400	500	40	1680	80
MSCWI02-05S12		12	167	477		820	84
MSCWI02-05S15		15	134	484		680	83
MSCWI02-05S24		24	83	474		390	84
MSCWI02-05D12		±12	±83	480		470#	83
MSCWI02-05D15		±15	±67	490		330#	82
MSCWI02-24S05	24 (9 ~ 36)	5	400	104	20	1680	80
MSCWI02-24S12		12	167	99		820	84
MSCWI02-24S15		15	134	99		680	85
MSCWI02-24S24		24	83	98		390	85
MSCWI02-24D12		±12	±83	100		470#	83
MSCWI02-24D15		±15	±67	101		330#	83
MSCWI02-48S05	48 (18 ~ 75)	5	400	53	10	1680	78
MSCWI02-48S12		12	167	51		820	82
MSCWI02-48S15		15	134	51		680	83
MSCWI02-48S24		24	83	49		390	84
MSCWI02-48D12		±12	±83	51		470#	82
MSCWI02-48D15		±15	±67	51		330#	82

For each output

Input Specifications

Parameter	Conditions / Model	Min.	Typ.	Max.	Unit
Input Surge Voltage (1 sec. max.)	5V Input Models	-0.7	---	15	VDC
	24V Input Models	-0.7	---	50	
	48V Input Models	-0.7	---	100	
Start-Up Threshold Voltage	5V Input Models	---	---	4.5	VDC
	24V Input Models	---	---	9	
	48V Input Models	---	---	18	
Start-Up Time (Power On)	Nominal Vin and Constant Resistive Load	---	---	30	ms
Short Circuit Input Power	All Models	---	---	1500	mW
Input Filter		Internal Pi Type			

Remote On/Off Specifications

Parameter	Conditions	Min.	Typ.	Max.	Unit
Converter On	Under 0.6 VDC or Open Circuit				
Converter Off	4.7 to 15 VDC				
Standby Input Current	Nominal Vin	---	---	3	mA

Output Specifications					
Parameter	Conditions	Min.	Typ.	Max.	Unit
Output Voltage Setting Accuracy		---	---	±1.0	%Vnom.
Output Voltage Balance	Dual Output, Balanced Loads	---	---	±2.0	%
Line Regulation	Vin=Min. to Max. @Full Load	---	---	±0.5	%
Load Regulation	Io=0% to 100%	---	---	±1.0	%
Load Cross Regulation (Dual Output)	Asymmetrical Load 25/100% Full Load	---	---	±5.0	%
Minimum Load	No minimum Load Requirement				
Ripple & Noise	0-20 MHz Bandwidth	---	---	50	mV _{P-P}
Transient Recovery Time	25% Load Step Change	---	250	---	µsec
Transient Response Deviation		---	±3	±5	%
Temperature Coefficient		---	---	±0.02	%/°C
Over Load Protection	Foldback	---	160	---	%
Short Circuit Protection	Continuous, Automatic Recovery				

General Specifications					
Parameter	Conditions	Min.	Typ.	Max.	Unit
I/O Isolation Voltage	60 Seconds	1500	---	---	VDC
	1 Second	1800	---	---	VDC
I/O Isolation Resistance	500 VDC	1000	---	---	MΩ
I/O Isolation Capacitance	100kHz, 1V	---	500	---	pF
Switching Frequency		100	---	---	kHz
MTBF(calculated)	MIL-HDBK-217F@25°C, Ground Benign	6,432,000	---	---	Hours
Moisture Sensitivity Level (MSL)	IPC/JEDEC J-STD-020D.1	Level 2			
Safety Approvals	UL/cUL 60950-1 recognition(UL certificate), IEC/EN 60950-1(CB-report)				
	UL/cUL 62368-1 recognition(UL certificate), IEC/EN 62368-1(CB-report)				

EMC Specifications				
Parameter	Standards & Level			Performance
	EMI	Conduction	EN 55032	Without external components
Radiation				
EMS ₍₄₎	EN 55024			
	ESD	EN 61000-4-2 Air ± 8kV, Contact ± 6kV		A
	Radiated immunity	EN 61000-4-3 10V/m		A
	Fast transient	EN 61000-4-4 ±2kV		A
	Surge	EN 61000-4-5 ±1kV		A
	Conducted immunity	EN 61000-4-6 10Vrms		A
	PFMF	EN 61000-4-8 3A/m		A

Environmental Specifications			
Parameter	Min.	Max.	Unit
Operating Ambient Temperature Range (See Power Derating Curve)	-40	+80	°C
Case Temperature	---	+95	°C
Storage Temperature	-55	+125	°C
Humidity (non condensing)	---	95	% rel. H
Lead-free Reflow Solder Process	IPC/JEDEC J-STD-020D.1		

Notes	
1	Specifications typical at Ta=+25°C, resistive load, nominal input voltage, rated output current unless otherwise noted.
2	We recommend to protect the converter by a slow blow fuse in the input supply line.
3	Other input and output voltage may be available, please contact MINMAX.
4	The external components might be required to meet EMS standard for some of test items. Please contact MINMAX for the solution in detail.
5	Specifications are subject to change without notice.
6	The repeated high voltage isolation testing of the converter can degrade isolation capability, to a lesser or greater degree depending on materials, construction, environment and reflow solder process. Any material is susceptible to eventual chemical degradation when subject to very high applied voltages thus implying that the number of tests should be strictly limited. We therefore strongly advise against repeated high voltage isolation testing, but if it is absolutely required, that the voltage be reduced by 20% from specified test voltage. Furthermore, the high voltage isolation capability after reflow solder process should be evaluated as it is applied on system.

Characteristic Curves

All test conditions are at 25°C The figures are identical for MSCWI02-05S05

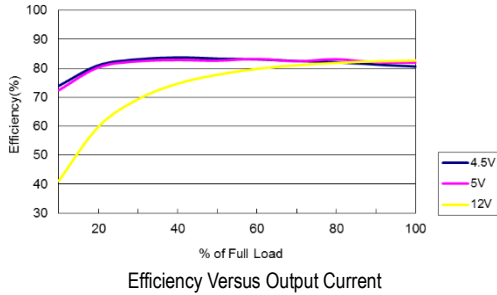

Efficiency Versus Output Current

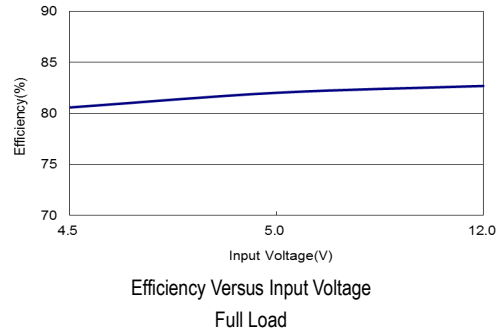

Efficiency Versus Input Voltage Full Load

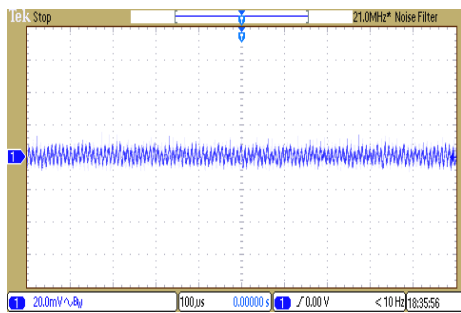

Typical Output Ripple and Noise
 $V_{in}=V_{in nom}$; Full Load

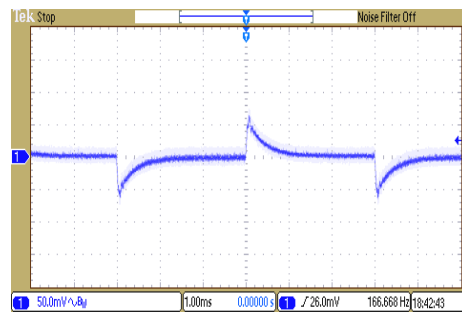

Transient Response to Dynamic Load Change
from 100% to 75% of Full Load ; $V_{in}=V_{in nom}$

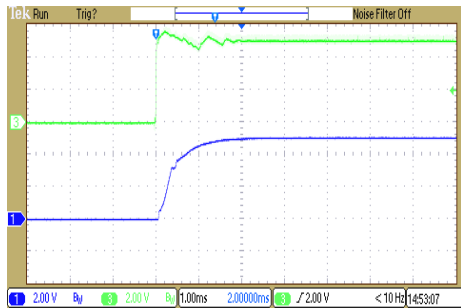

Typical Input Start-Up and Output Rise Characteristic
 $V_{in}=V_{in nom}$; Full Load

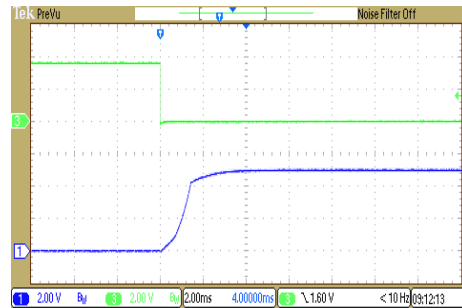

ON/OFF Voltage Start-Up and Output Rise Characteristic
 $V_{in}=V_{in nom}$; Full Load

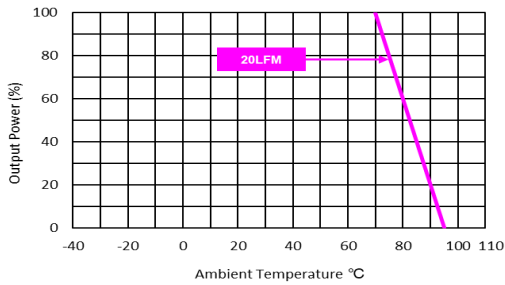

Derating Output Current Versus Ambient Temperature and Airflow
 $V_{in}=V_{in nom}$

Characteristic Curves

All test conditions are at 25°C The figures are identical for MSCWI02-05S12

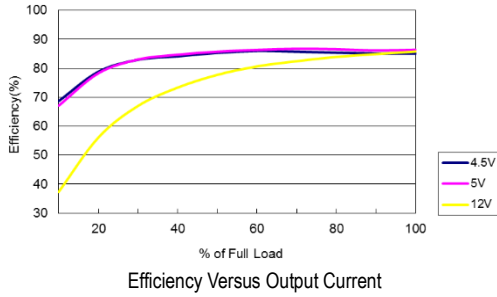

Efficiency Versus Output Current

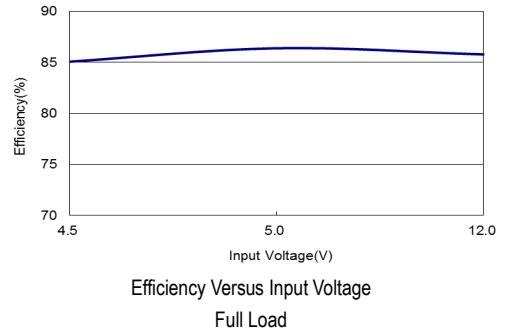

Efficiency Versus Input Voltage Full Load

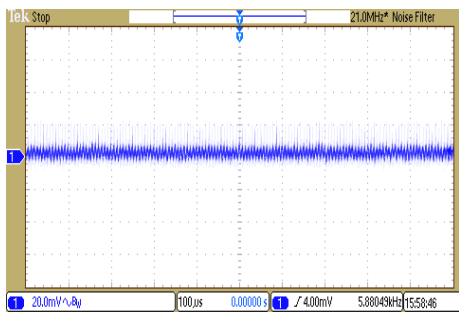

Typical Output Ripple and Noise
 $V_{in}=V_{in\ nom}$; Full Load

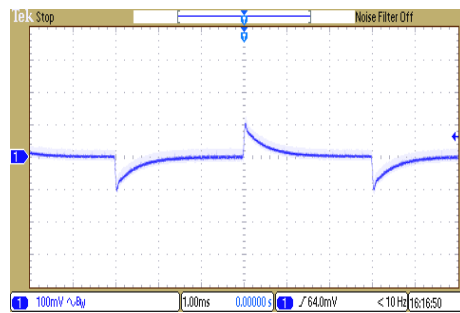

Transient Response to Dynamic Load Change
from 100% to 75% of Full Load ; $V_{in}=V_{in\ nom}$

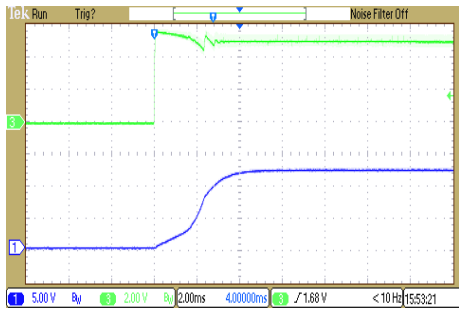

Typical Input Start-Up and Output Rise Characteristic
 $V_{in}=V_{in\ nom}$; Full Load

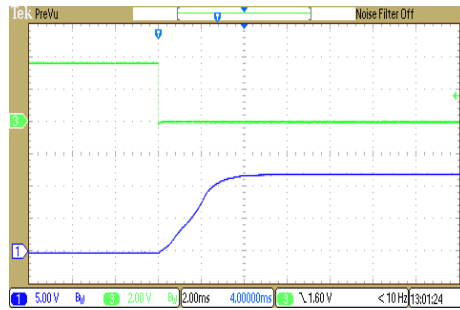

ON/OFF Voltage Start-Up and Output Rise Characteristic
 $V_{in}=V_{in\ nom}$; Full Load

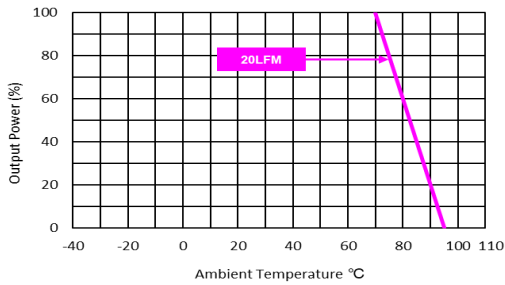

Derating Output Current Versus Ambient Temperature and Airflow
 $V_{in}=V_{in\ nom}$

Characteristic Curves

All test conditions are at 25°C The figures are identical for MSCWI02-05S15

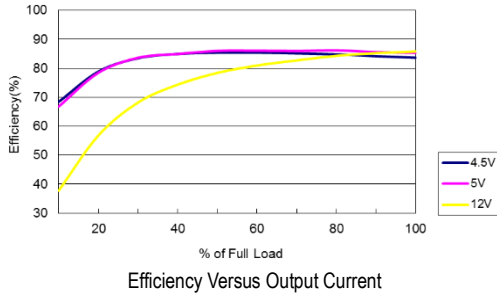

Efficiency Versus Output Current

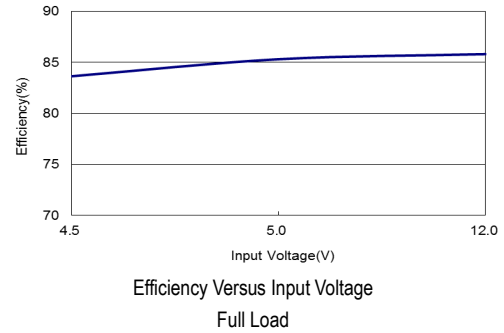

Efficiency Versus Input Voltage Full Load

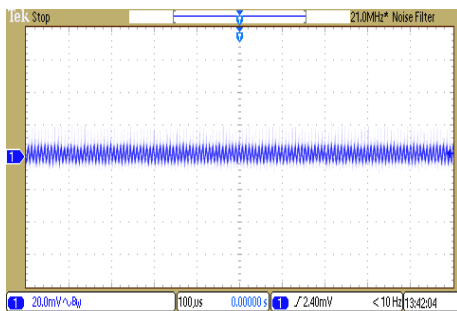

Typical Output Ripple and Noise
 $V_{in}=V_{in nom}$; Full Load

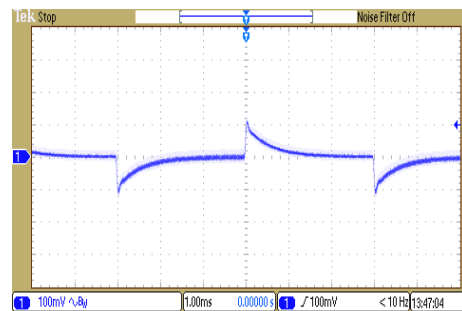

Transient Response to Dynamic Load Change
from 100% to 75% of Full Load; $V_{in}=V_{in nom}$

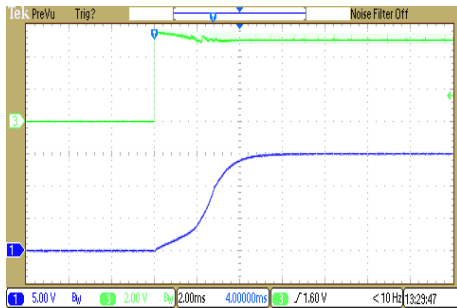

Typical Input Start-Up and Output Rise Characteristic
 $V_{in}=V_{in nom}$; Full Load

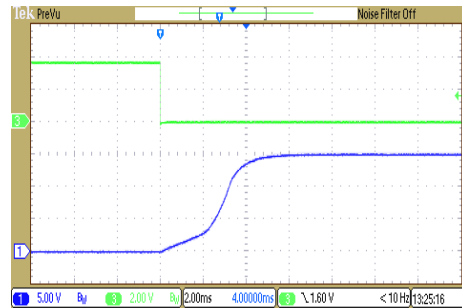

ON/OFF Voltage Start-Up and Output Rise Characteristic
 $V_{in}=V_{in nom}$; Full Load

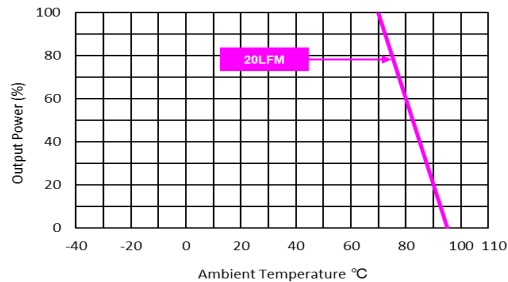

Derating Output Current Versus Ambient Temperature and Airflow
 $V_{in}=V_{in nom}$

Characteristic Curves

All test conditions are at 25°C The figures are identical for MSCWI02-05S24

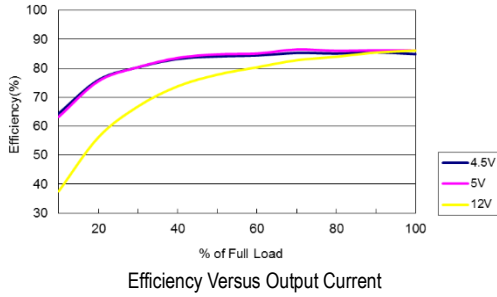

Efficiency Versus Output Current

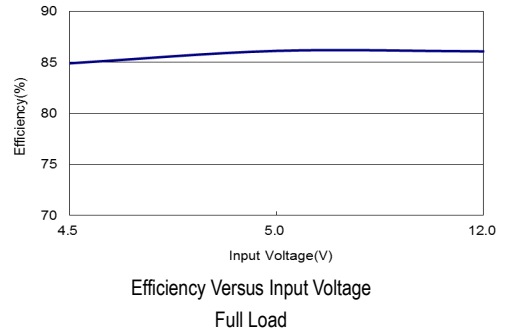

Efficiency Versus Input Voltage Full Load

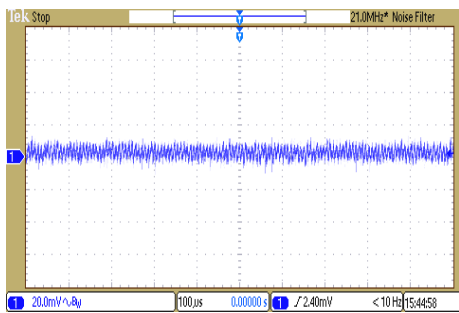

Typical Output Ripple and Noise
 $V_{in}=V_{in nom}$; Full Load

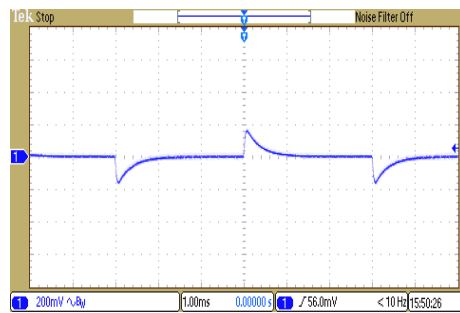

Transient Response to Dynamic Load Change
from 100% to 75% of Full Load ; $V_{in}=V_{in nom}$

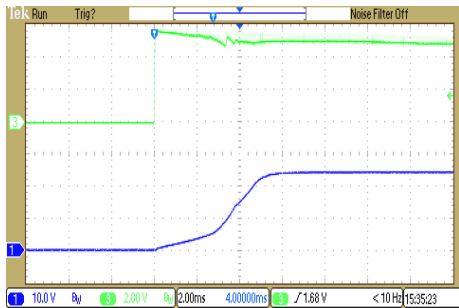

Typical Input Start-Up and Output Rise Characteristic
 $V_{in}=V_{in nom}$; Full Load

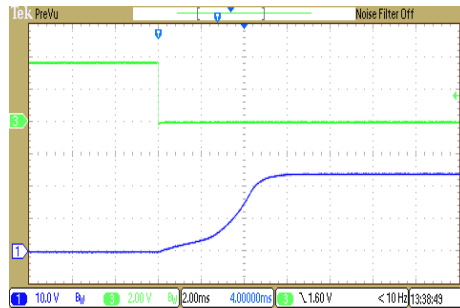

ON/OFF Voltage Start-Up and Output Rise Characteristic
 $V_{in}=V_{in nom}$; Full Load

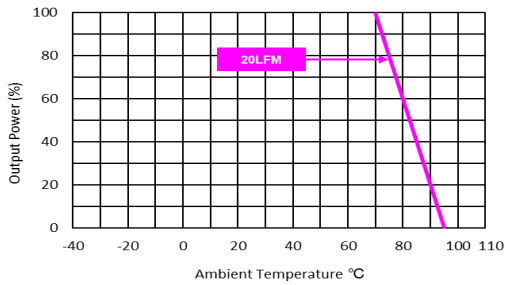

Derating Output Current Versus Ambient Temperature and Airflow
 $V_{in}=V_{in nom}$

Characteristic Curves

All test conditions are at 25°C The figures are identical for MSCWI02-05D12

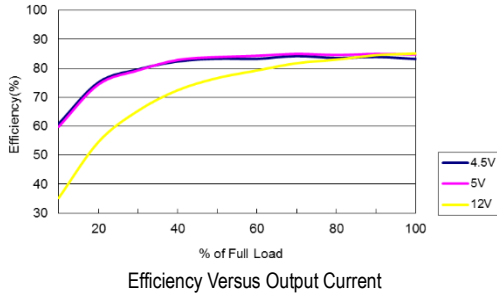

Efficiency Versus Output Current

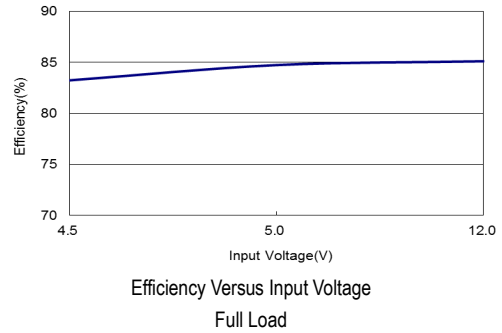

Efficiency Versus Input Voltage Full Load

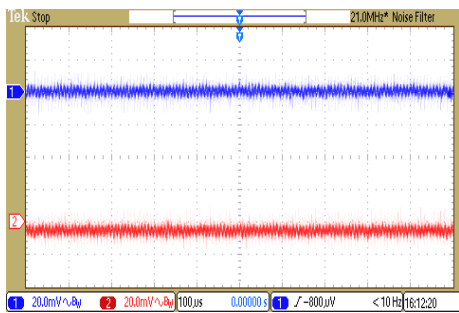

Typical Output Ripple and Noise
 $V_{in}=V_{in\ nom}$; Full Load

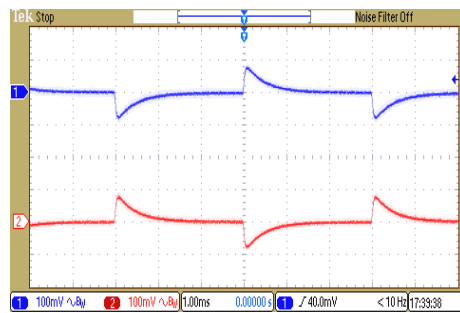

Transient Response to Dynamic Load Change
from 100% to 75% of Full Load ; $V_{in}=V_{in\ nom}$

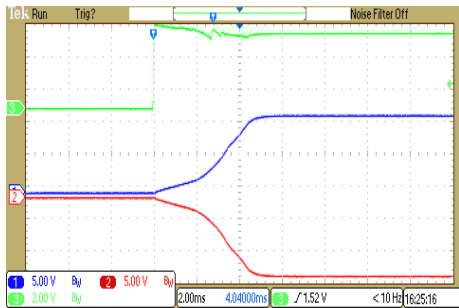

Typical Input Start-Up and Output Rise Characteristic
 $V_{in}=V_{in\ nom}$; Full Load

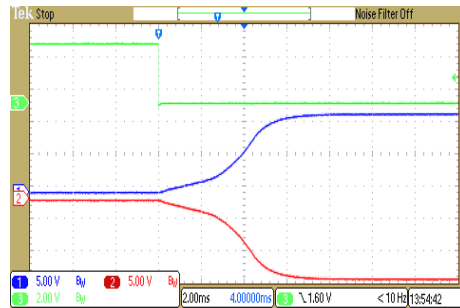

ON/OFF Voltage Start-Up and Output Rise Characteristic
 $V_{in}=V_{in\ nom}$; Full Load

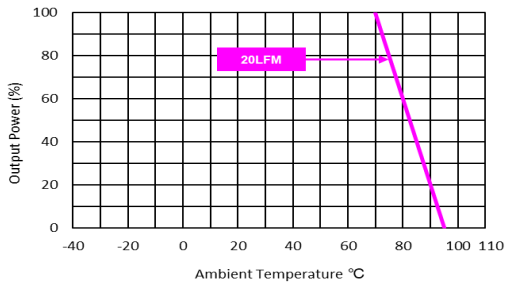

Derating Output Current Versus Ambient Temperature and Airflow
 $V_{in}=V_{in\ nom}$

Characteristic Curves

All test conditions are at 25°C The figures are identical for MSCWI02-05D15

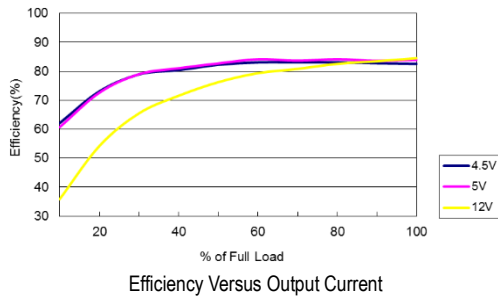

Efficiency Versus Output Current

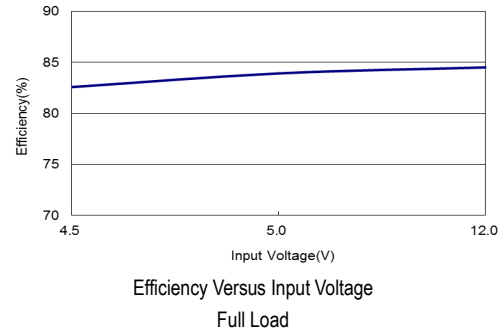

Efficiency Versus Input Voltage Full Load

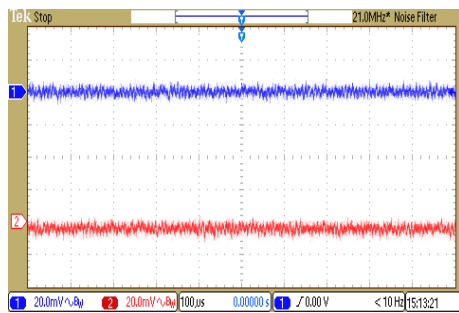

Typical Output Ripple and Noise
 $V_{in}=V_{in\ nom}$; Full Load

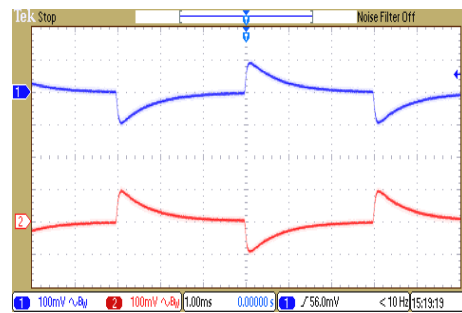

Transient Response to Dynamic Load Change
from 100% to 75% of Full Load ; $V_{in}=V_{in\ nom}$

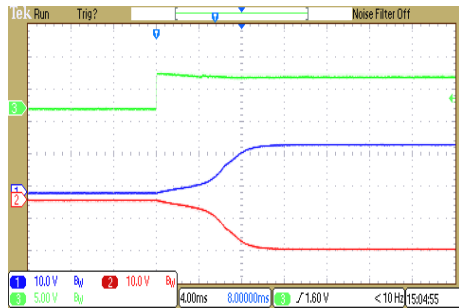

Typical Input Start-Up and Output Rise Characteristic
 $V_{in}=V_{in\ nom}$; Full Load

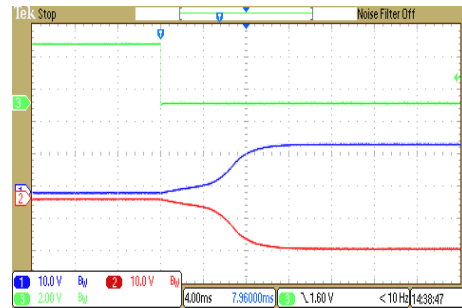

ON/OFF Voltage Start-Up and Output Rise Characteristic
 $V_{in}=V_{in\ nom}$; Full Load

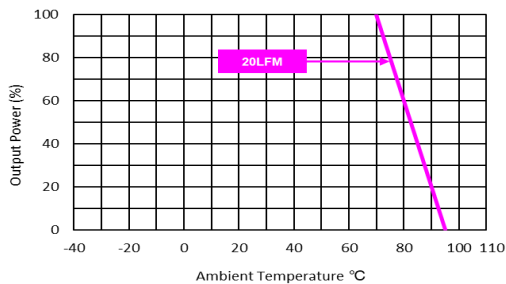

Derating Output Current Versus Ambient Temperature and Airflow
 $V_{in}=V_{in\ nom}$

Characteristic Curves

All test conditions are at 25°C The figures are identical for MSCWI02-24S05

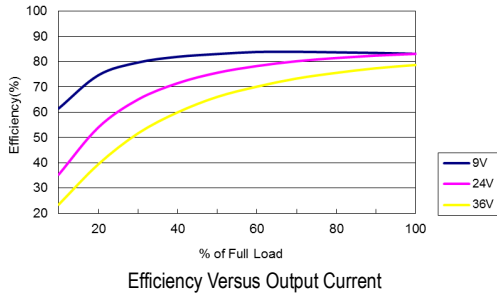

Efficiency Versus Output Current

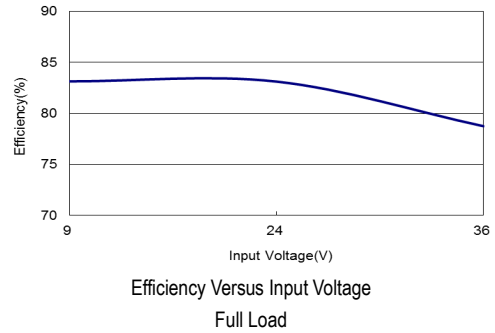

Efficiency Versus Input Voltage Full Load

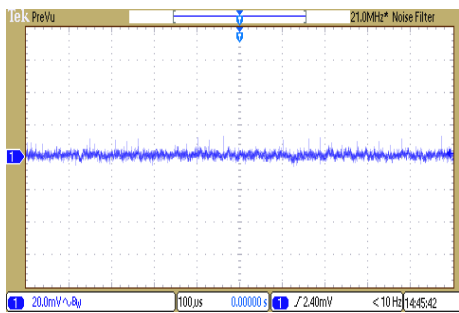

Typical Output Ripple and Noise
 $V_{in}=V_{in\ nom}$; Full Load

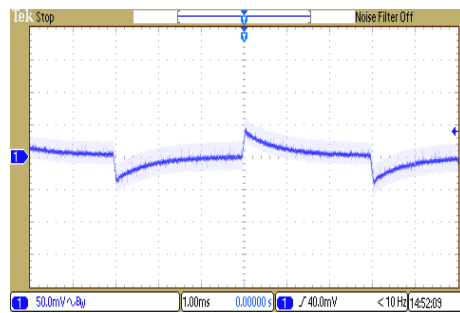

Transient Response to Dynamic Load Change
from 100% to 75% of Full Load ; $V_{in}=V_{in\ nom}$

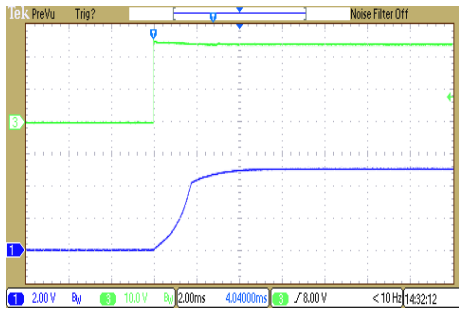

Typical Input Start-Up and Output Rise Characteristic
 $V_{in}=V_{in\ nom}$; Full Load

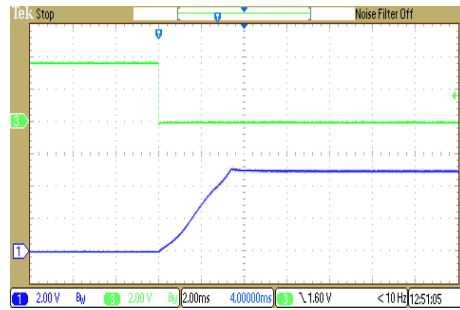

ON/OFF Voltage Start-Up and Output Rise Characteristic
 $V_{in}=V_{in\ nom}$; Full Load

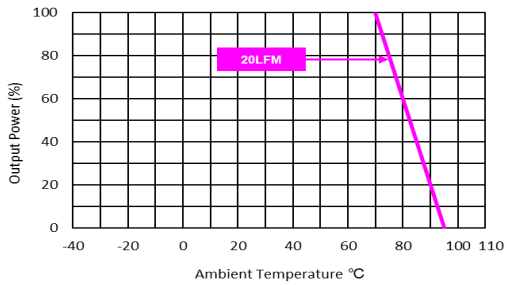

Derating Output Current Versus Ambient Temperature and Airflow
 $V_{in}=V_{in\ nom}$

Characteristic Curves

All test conditions are at 25°C The figures are identical for MSCWI02-24S12

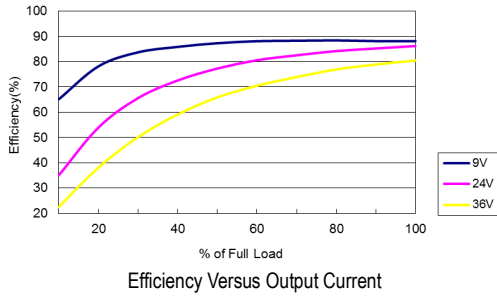

Efficiency Versus Output Current

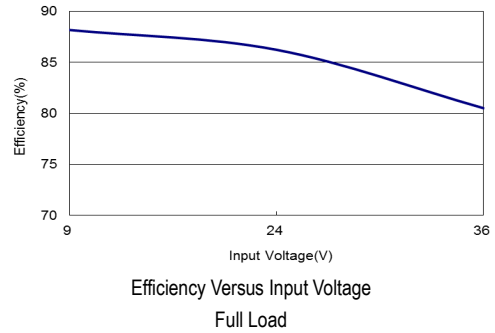

Efficiency Versus Input Voltage Full Load

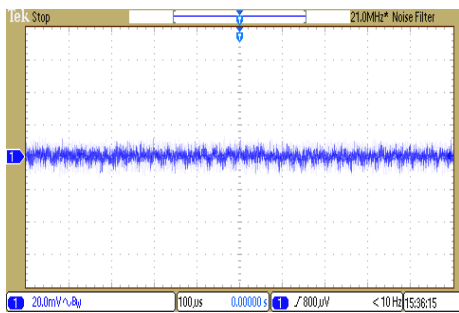

Typical Output Ripple and Noise
 $V_{in}=V_{in\ nom}$; Full Load

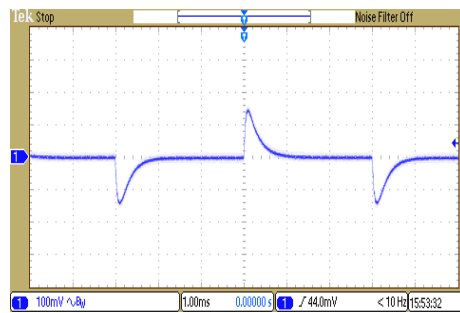

Transient Response to Dynamic Load Change
from 100% to 75% of Full Load ; $V_{in}=V_{in\ nom}$

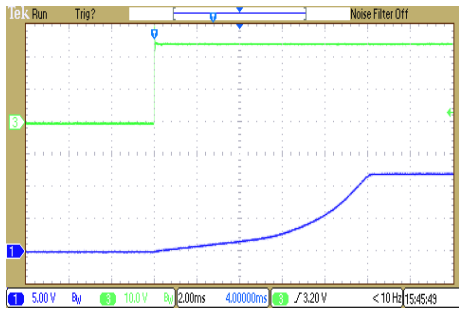

Typical Input Start-Up and Output Rise Characteristic
 $V_{in}=V_{in\ nom}$; Full Load

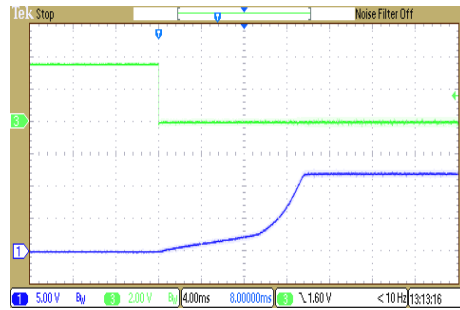

ON/OFF Voltage Start-Up and Output Rise Characteristic
 $V_{in}=V_{in\ nom}$; Full Load

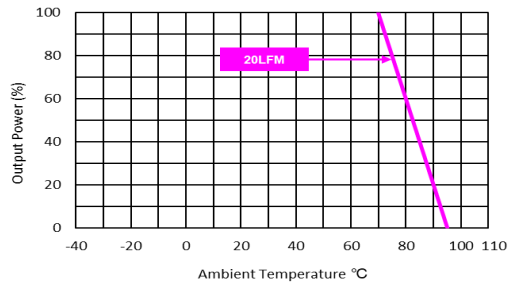

Derating Output Current Versus Ambient Temperature and Airflow
 $V_{in}=V_{in\ nom}$

Characteristic Curves

All test conditions are at 25°C The figures are identical for MSCWI02-24S15

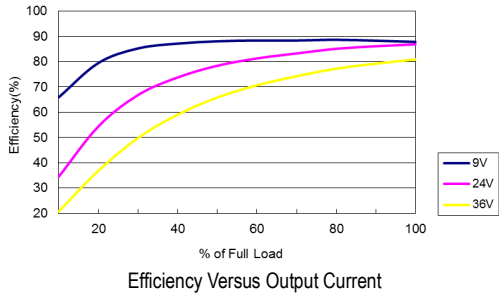

Efficiency Versus Output Current

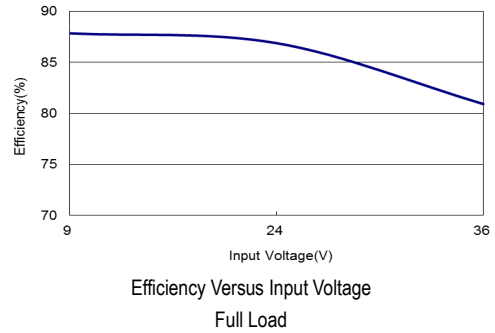

Efficiency Versus Input Voltage Full Load

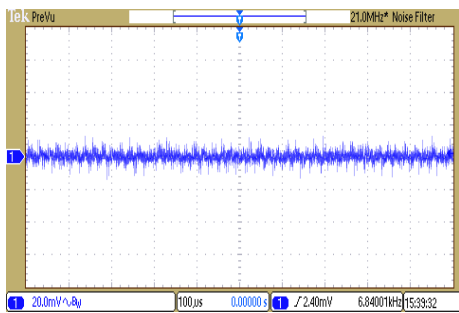

Typical Output Ripple and Noise
 $V_{in}=V_{in\ nom}$; Full Load

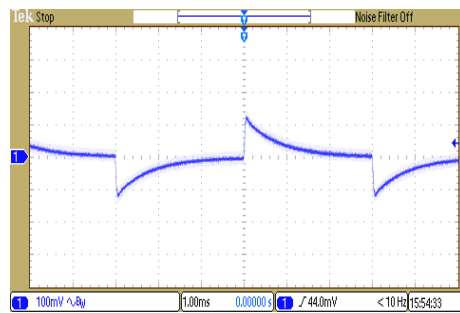

Transient Response to Dynamic Load Change
from 100% to 75% of Full Load; $V_{in}=V_{in\ nom}$

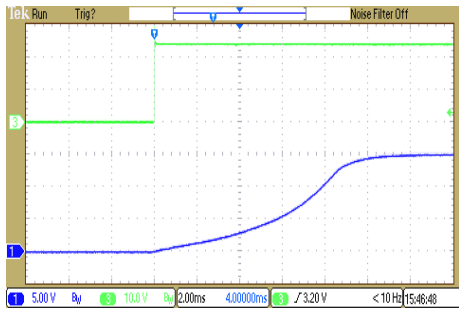

Typical Input Start-Up and Output Rise Characteristic
 $V_{in}=V_{in\ nom}$; Full Load

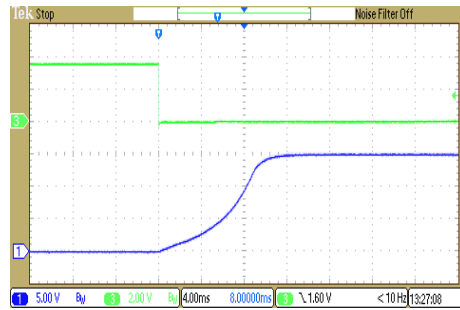

ON/OFF Voltage Start-Up and Output Rise Characteristic
 $V_{in}=V_{in\ nom}$; Full Load

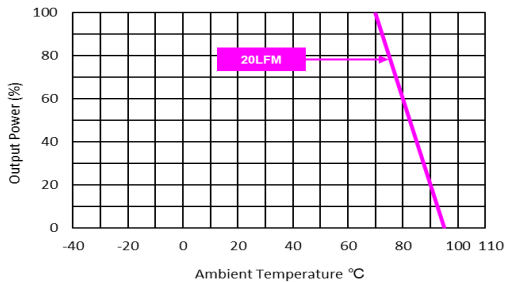

Derating Output Current Versus Ambient Temperature and Airflow
 $V_{in}=V_{in\ nom}$

Characteristic Curves

All test conditions are at 25°C The figures are identical for MSCWI02-24S24

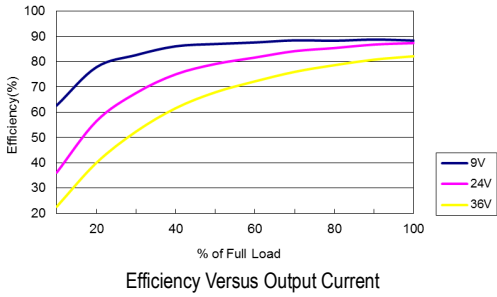

Efficiency Versus Output Current

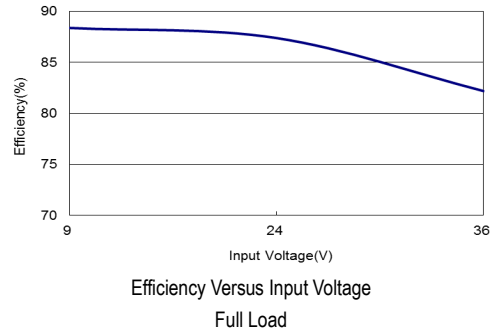

Efficiency Versus Input Voltage Full Load

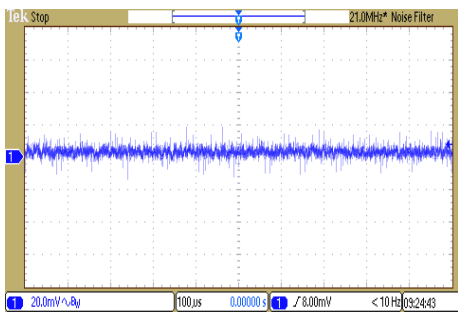

Typical Output Ripple and Noise
 $V_{in}=V_{in\ nom}$; Full Load

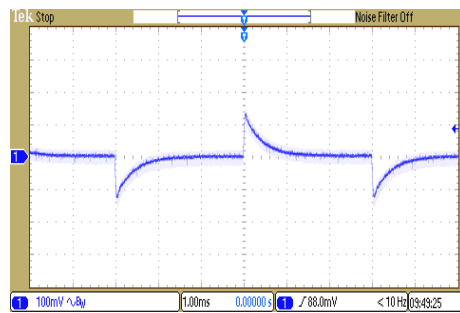

Transient Response to Dynamic Load Change
from 100% to 75% of Full Load ; $V_{in}=V_{in\ nom}$

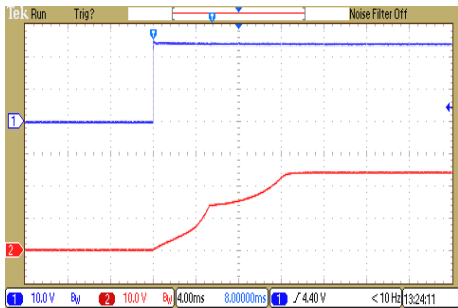

Typical Input Start-Up and Output Rise Characteristic
 $V_{in}=V_{in\ nom}$; Full Load

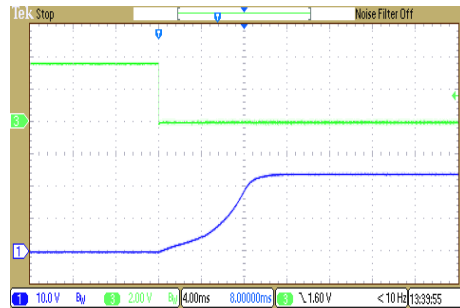

ON/OFF Voltage Start-Up and Output Rise Characteristic
 $V_{in}=V_{in\ nom}$; Full Load

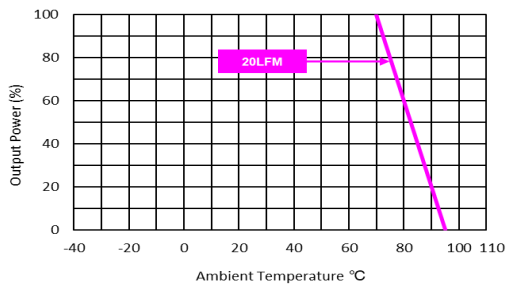

Derating Output Current Versus Ambient Temperature and Airflow
 $V_{in}=V_{in\ nom}$

Characteristic Curves

All test conditions are at 25°C The figures are identical for MSCWI02-24D12

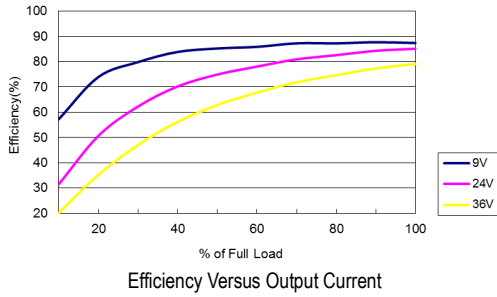

Efficiency Versus Output Current

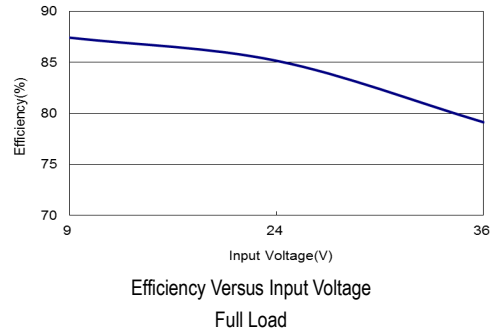

Efficiency Versus Input Voltage Full Load

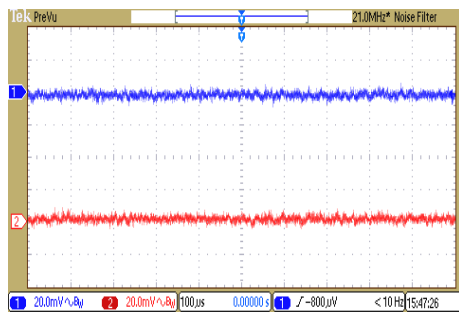

Typical Output Ripple and Noise
 $V_{in}=V_{in\ nom}$; Full Load

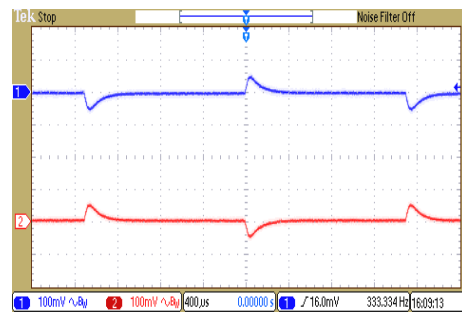

Transient Response to Dynamic Load Change
from 100% to 75% of Full Load ; $V_{in}=V_{in\ nom}$

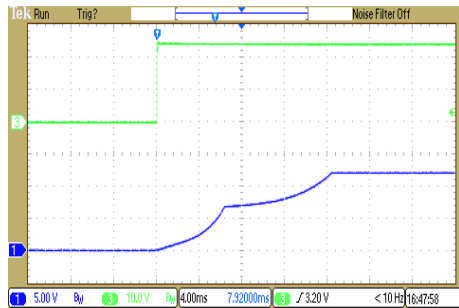

Typical Input Start-Up and Output Rise Characteristic
 $V_{in}=V_{in\ nom}$; Full Load

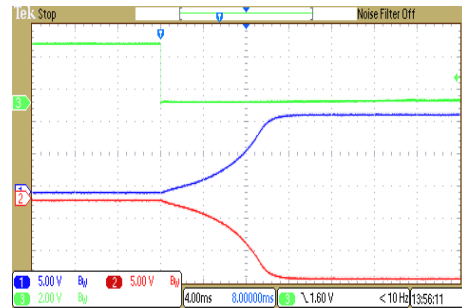

ON/OFF Voltage Start-Up and Output Rise Characteristic
 $V_{in}=V_{in\ nom}$; Full Load

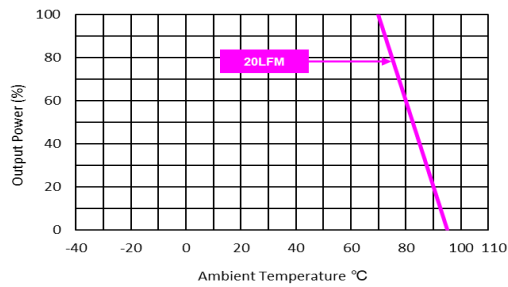

Derating Output Current Versus Ambient Temperature and Airflow
 $V_{in}=V_{in\ nom}$

Characteristic Curves

All test conditions are at 25°C The figures are identical for MSCWI02-24D15

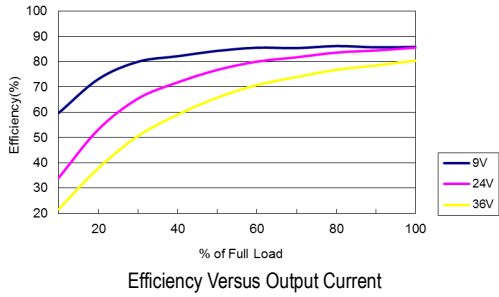

Efficiency Versus Output Current

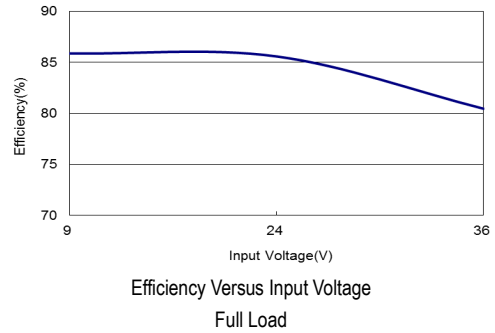

Efficiency Versus Input Voltage Full Load

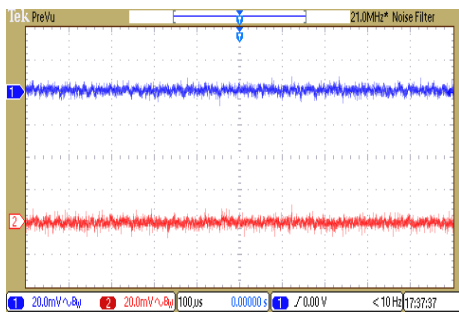

Typical Output Ripple and Noise
 $V_{in}=V_{in\ nom}$; Full Load

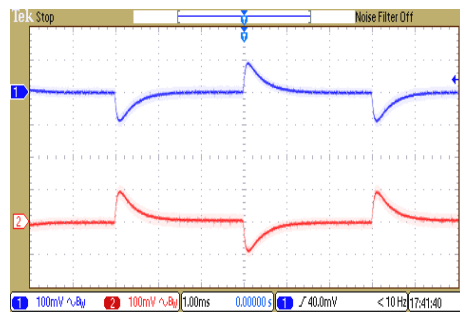

Transient Response to Dynamic Load Change
from 100% to 75% of Full Load ; $V_{in}=V_{in\ nom}$

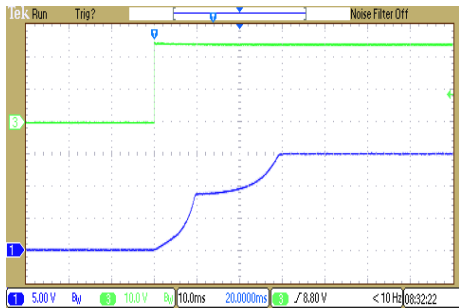

Typical Input Start-Up and Output Rise Characteristic
 $V_{in}=V_{in\ nom}$; Full Load

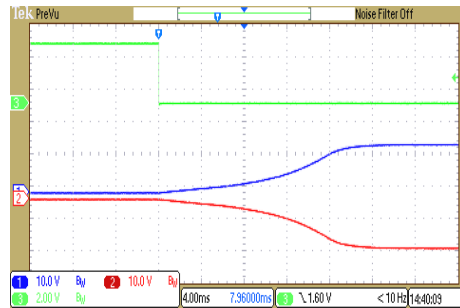

ON/OFF Voltage Start-Up and Output Rise Characteristic
 $V_{in}=V_{in\ nom}$; Full Load

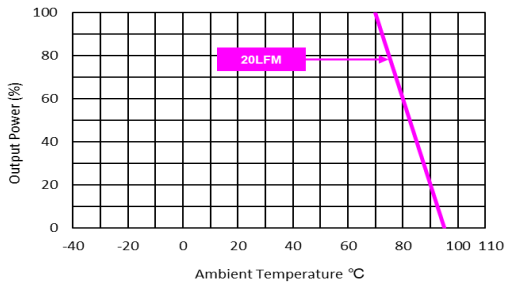

Derating Output Current Versus Ambient Temperature and Airflow
 $V_{in}=V_{in\ nom}$

Characteristic Curves

All test conditions are at 25°C The figures are identical for MSCWI02-48S05

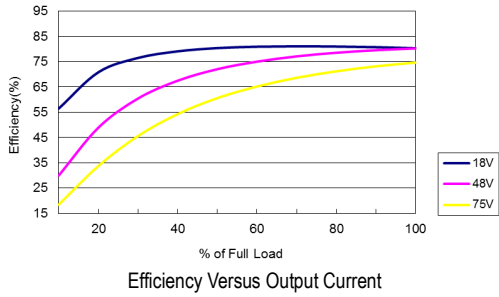

Efficiency Versus Output Current

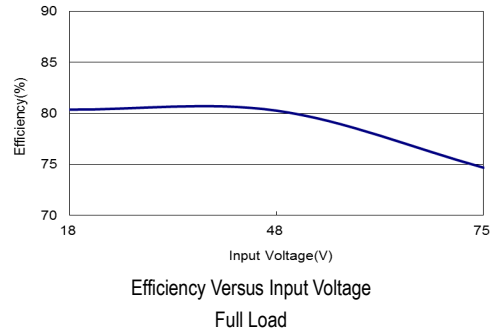

Efficiency Versus Input Voltage Full Load

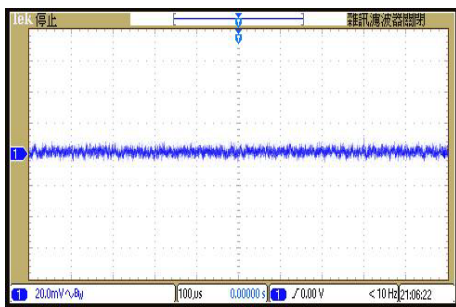

Typical Output Ripple and Noise
 $V_{in}=V_{in\ nom}$; Full Load

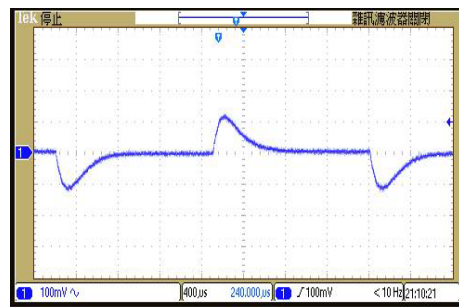

Transient Response to Dynamic Load Change
from 100% to 75% of Full Load; $V_{in}=V_{in\ nom}$



Typical Input Start-Up and Output Rise Characteristic
 $V_{in}=V_{in\ nom}$; Full Load

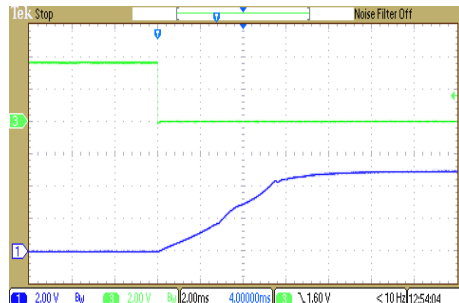

ON/OFF Voltage Start-Up and Output Rise Characteristic
 $V_{in}=V_{in\ nom}$; Full Load

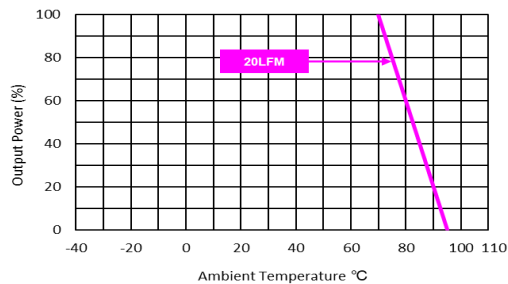

Derating Output Current Versus Ambient Temperature and Airflow
 $V_{in}=V_{in\ nom}$

Characteristic Curves

All test conditions are at 25°C The figures are identical for MSCWI02-48S12

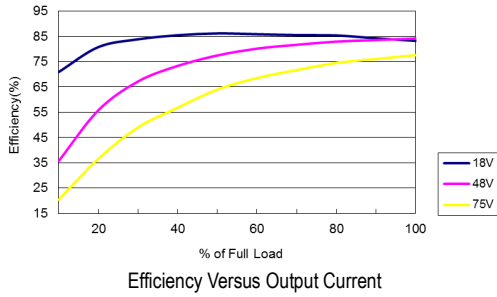

Efficiency Versus Output Current

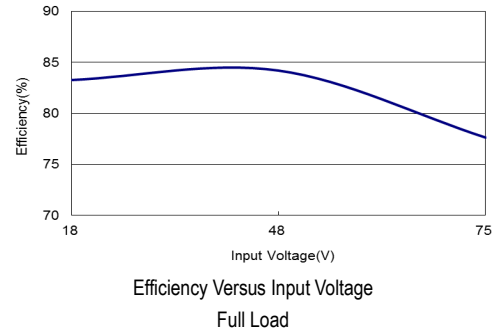

Efficiency Versus Input Voltage Full Load

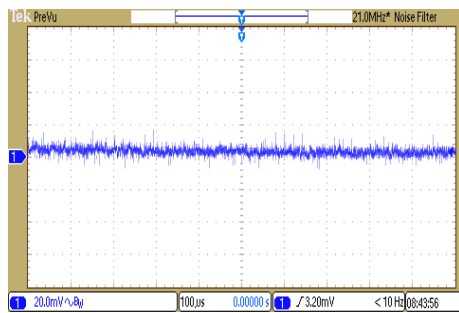

Typical Output Ripple and Noise
 $V_{in}=V_{in\ nom}$; Full Load

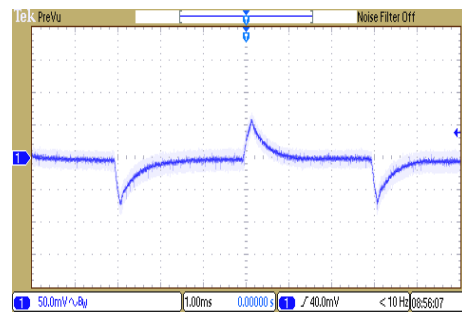

Transient Response to Dynamic Load Change
from 100% to 75% of Full Load ; $V_{in}=V_{in\ nom}$

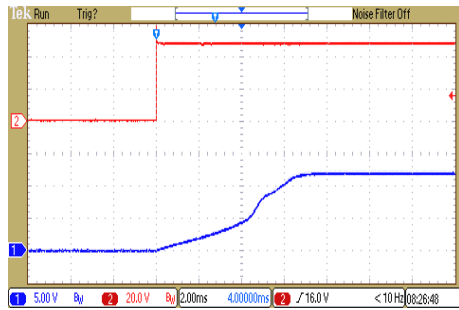

Typical Input Start-Up and Output Rise Characteristic
 $V_{in}=V_{in\ nom}$; Full Load

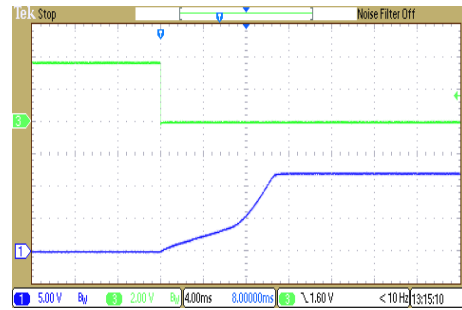

ON/OFF Voltage Start-Up and Output Rise Characteristic
 $V_{in}=V_{in\ nom}$; Full Load

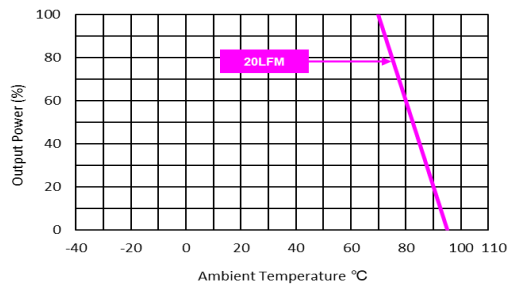

Derating Output Current Versus Ambient Temperature and Airflow
 $V_{in}=V_{in\ nom}$

Characteristic Curves

All test conditions are at 25°C The figures are identical for MSCWI02-48S15

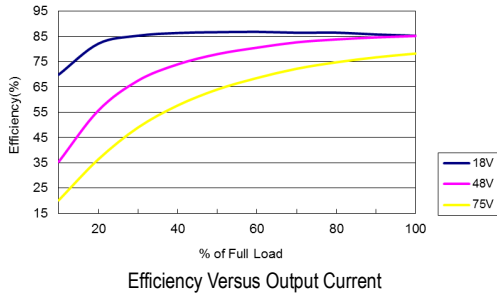

Efficiency Versus Output Current

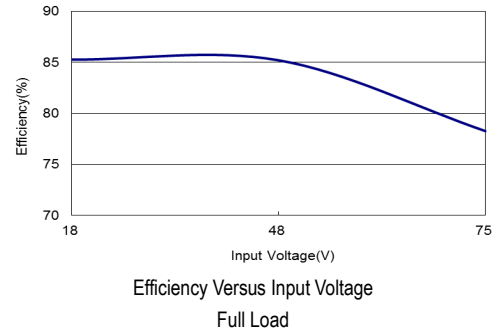

Efficiency Versus Input Voltage Full Load

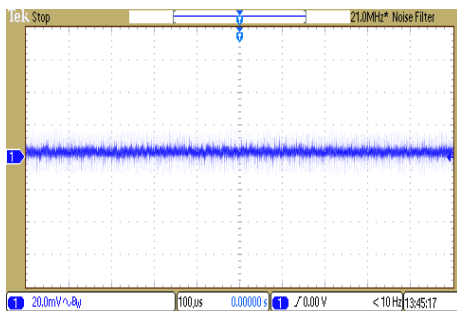

Typical Output Ripple and Noise
 $V_{in}=V_{in\ nom}$; Full Load

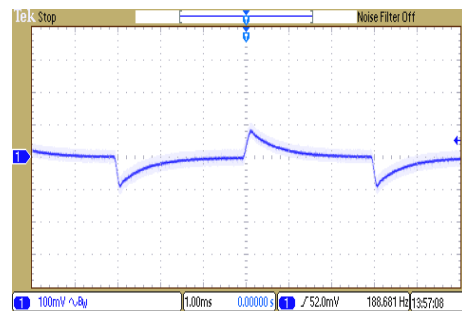

Transient Response to Dynamic Load Change
from 100% to 75% of Full Load ; $V_{in}=V_{in\ nom}$

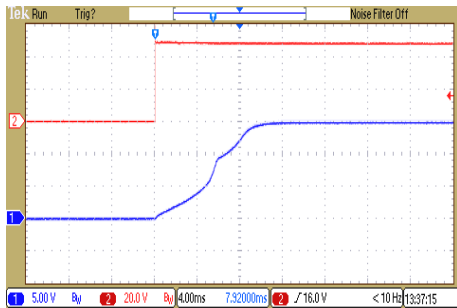

Typical Input Start-Up and Output Rise Characteristic
 $V_{in}=V_{in\ nom}$; Full Load

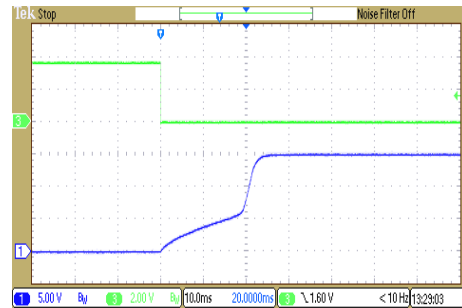

ON/OFF Voltage Start-Up and Output Rise Characteristic
 $V_{in}=V_{in\ nom}$; Full Load

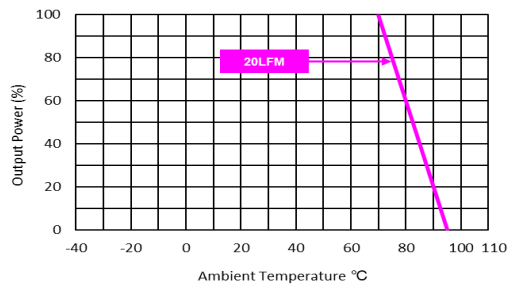

Derating Output Current Versus Ambient Temperature and Airflow
 $V_{in}=V_{in\ nom}$

Characteristic Curves

All test conditions are at 25°C The figures are identical for MSCWI02-48S24

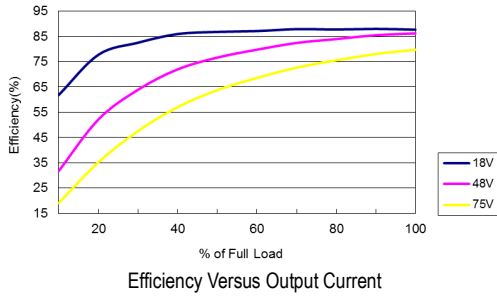

Efficiency Versus Output Current

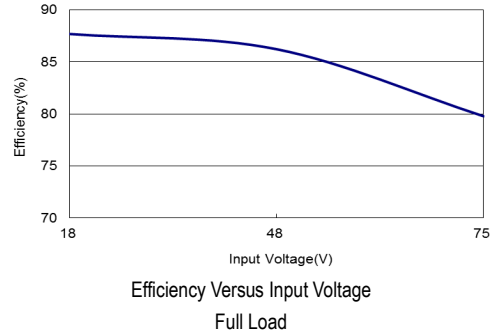

Efficiency Versus Input Voltage
Full Load

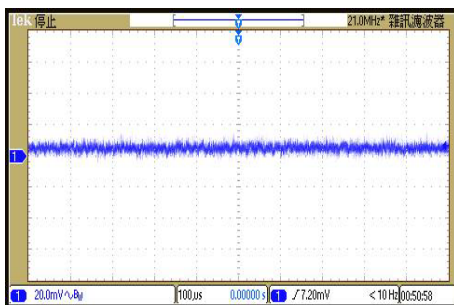

Typical Output Ripple and Noise
 $V_{in}=V_{in\ nom}$; Full Load

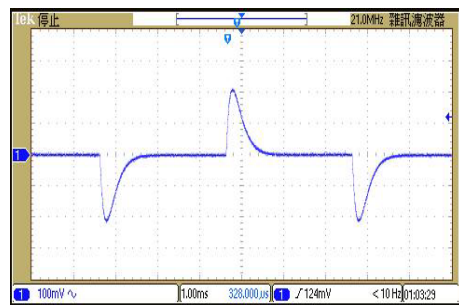

Transient Response to Dynamic Load Change
from 100% to 75% of Full Load ; $V_{in}=V_{in\ nom}$

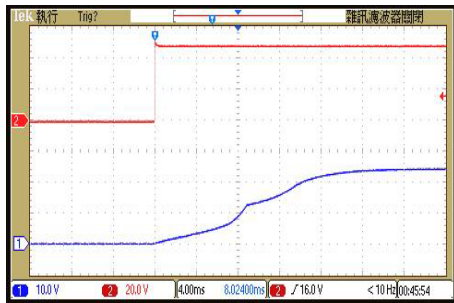

Typical Input Start-Up and Output Rise Characteristic
 $V_{in}=V_{in\ nom}$; Full Load

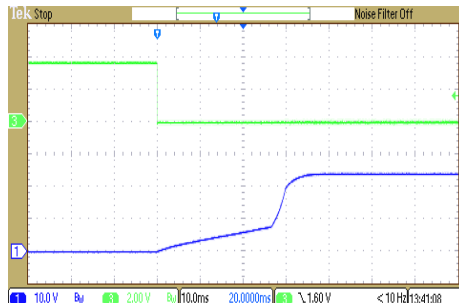

ON/OFF Voltage Start-Up and Output Rise Characteristic
 $V_{in}=V_{in\ nom}$; Full Load

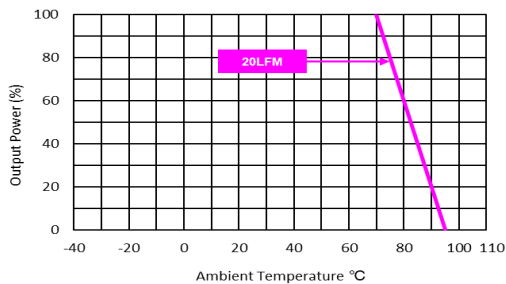

Derating Output Current Versus Ambient Temperature and Airflow
 $V_{in}=V_{in\ nom}$

Characteristic Curves

All test conditions are at 25°C The figures are identical for MSCWI02-48D12

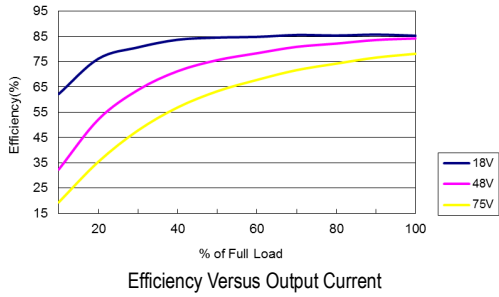

Efficiency Versus Output Current

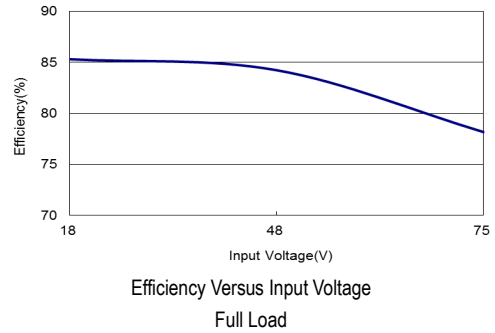

Efficiency Versus Input Voltage Full Load

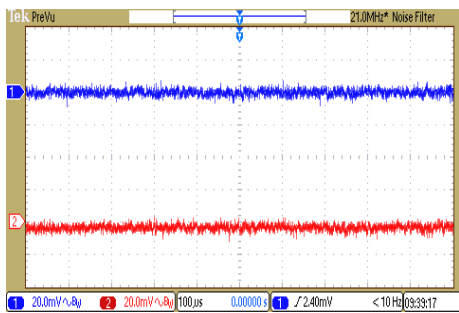

Typical Output Ripple and Noise
 $V_{in}=V_{in\ nom}$; Full Load

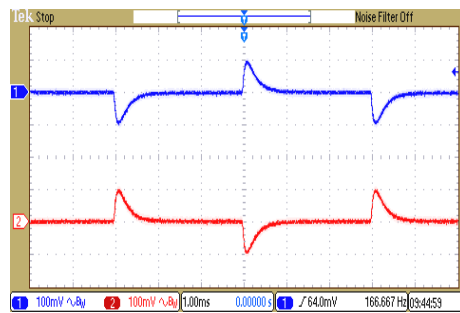

Transient Response to Dynamic Load Change
from 100% to 75% of Full Load ; $V_{in}=V_{in\ nom}$

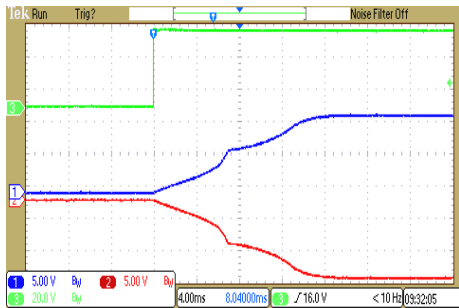

Typical Input Start-Up and Output Rise Characteristic
 $V_{in}=V_{in\ nom}$; Full Load

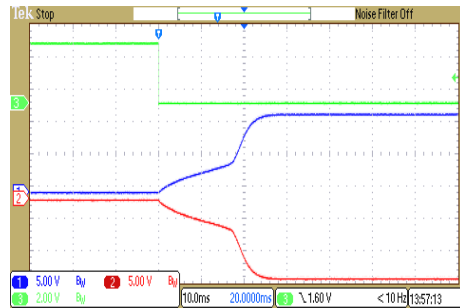

ON/OFF Voltage Start-Up and Output Rise Characteristic
 $V_{in}=V_{in\ nom}$; Full Load

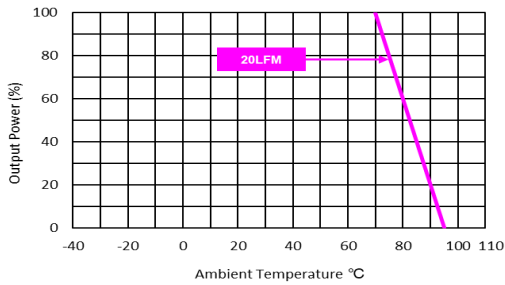

Derating Output Current Versus Ambient Temperature and Airflow
 $V_{in}=V_{in\ nom}$

Characteristic Curves

All test conditions are at 25°C The figures are identical for MSCWI02-48D15

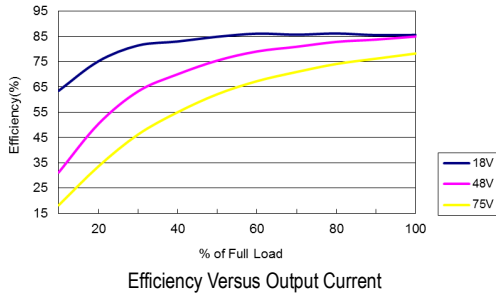

Efficiency Versus Output Current

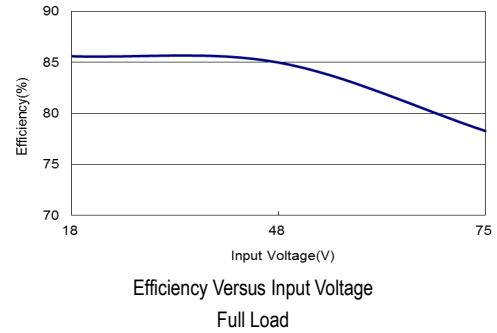

Efficiency Versus Input Voltage Full Load

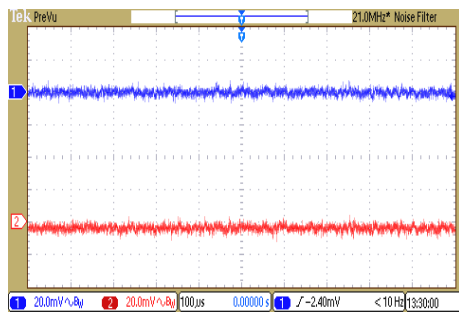

Typical Output Ripple and Noise
 $V_{in}=V_{in nom}$; Full Load

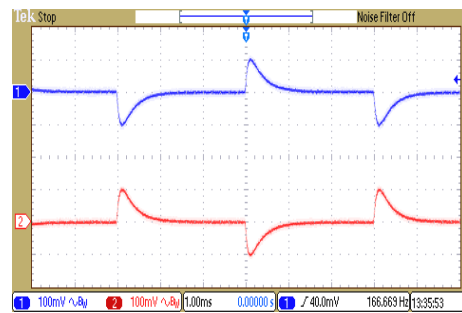

Transient Response to Dynamic Load Change
from 100% to 75% of Full Load; $V_{in}=V_{in nom}$

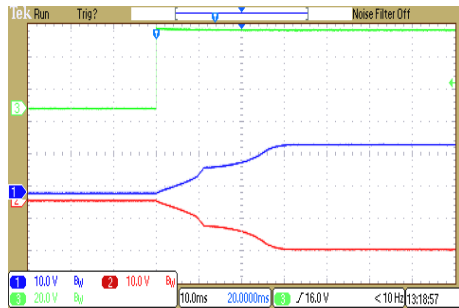

Typical Input Start-Up and Output Rise Characteristic
 $V_{in}=V_{in nom}$; Full Load

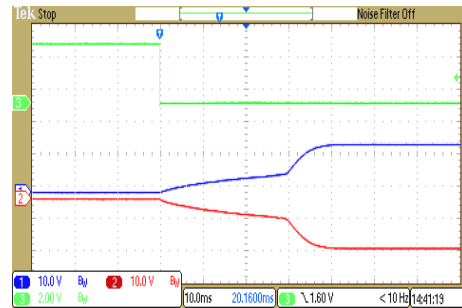

ON/OFF Voltage Start-Up and Output Rise Characteristic
 $V_{in}=V_{in nom}$; Full Load

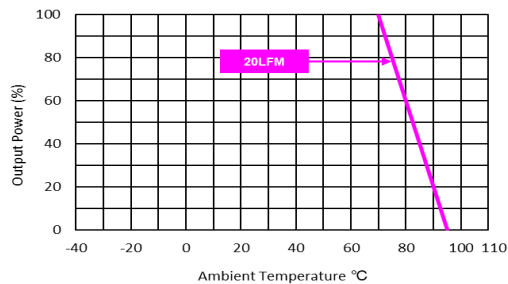

Derating Output Current Versus Ambient Temperature and Airflow
 $V_{in}=V_{in nom}$

Package Specifications

Mechanical Dimensions

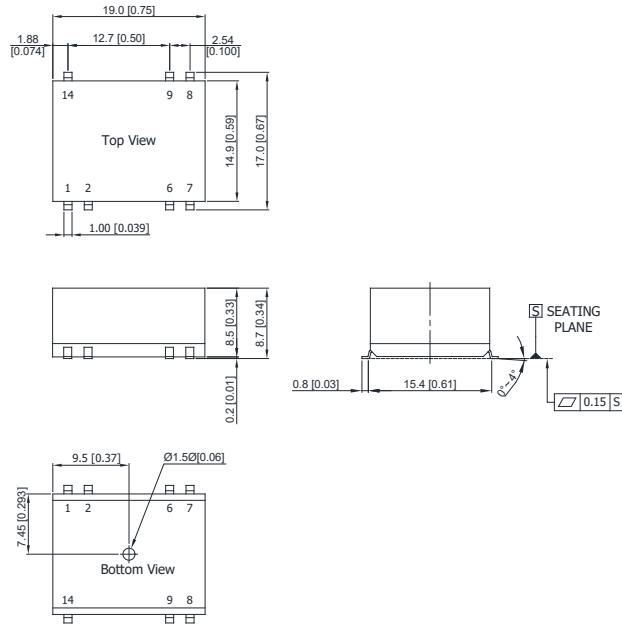

Connecting Pin Patterns

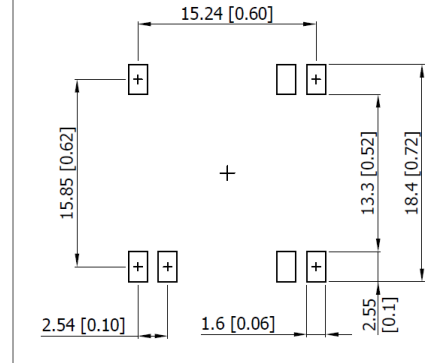

- ▶ All dimensions in mm (inches)
- ▶ Tolerance: X.X±0.5 (X.XX±0.02)
X.XX±0.25 (X.XXX±0.01)
- ▶ Pins ±0.05(±0.002)

Pin Connections

Pin	Single Output	Dual Output
1	-Vin	-Vin
2	Remote On/Off	Remote On/Off
6	NC	Common
7	NC	-Vout
8	+Vout	+Vout
9	-Vout	Common
14	+Vin	+Vin

NC: No Connection

Physical Characteristics

Case Size	: 19.0x14.9x8.5mm (0.75x0.59x0.33 inches)
Case Material	: Plastic resin (flammability to UL 94V-0 rated)
Pin Material	: Phosphor Bronze
Weight	: 3.5g

Test Setup

Peak-to-Peak Output Noise Measurement Test

Refer to the output specifications or add 4.7 μ F capacitor if the output specifications undefine Cout. Scope measurement should be made by using a BNC socket, measurement bandwidth is 0-20 MHz. Position the load between 50 mm and 75 mm from the DC-DC Converter.

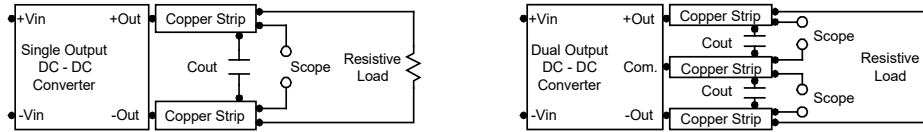

Technical Notes

Remote On/Off

Only one type of remote ON/OFF control is available for MSCWI02. The module will turn on during the ON/OFF pin open or high impedance between ON/OFF pin and -Vin pin. The module will turn off if the ON/OFF pin is applied with a current of 2~4mA.

Maximum Capacitive Load

The MSCWI02 series has limitation of maximum connected capacitance at the output. The power module may be operated in current limiting mode during start-up, affecting the ramp-up and the startup time. The maximum capacitance can be found in the data sheet.

Overload Protection

To provide protection in a fault (output overload) condition, the unit is equipped with internal current limiting circuitry and can endure current limiting for an unlimited duration. At the point of current-limit inception, the unit shifts from voltage control to current control. The unit operates normally once the output current is brought back into its specified range.

Input Source Impedance

The power module should be connected to a low ac-impedance input source. Highly inductive source impedances can affect the stability of the power module. In applications where power is supplied over long lines and output loading is high, it may be necessary to use a capacitor at the input to ensure startup. Capacitor mounted close to the power module helps ensure stability of the unit, it is commended to use a good quality low Equivalent Series Resistance (ESR < 1.0 Ω at 100 kHz) capacitor of a 4.7 μ F for the 5V input devices and a 2.2 μ F for the 24V and 48V devices.

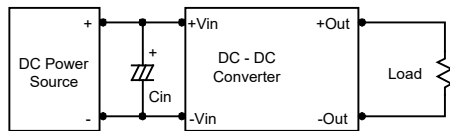

Output Ripple Reduction

A good quality low ESR capacitor placed as close as practicable across the load will give the best ripple and noise performance. To reduce output ripple, it is recommended to use 3.3 μ F capacitors at the output.



Thermal Considerations

Many conditions affect the thermal performance of the power module, such as orientation, airflow over the module and board spacing. To avoid exceeding the maximum temperature rating of the components inside the power module, the case temperature must be kept below 95°C. The derating curves are determined from measurements obtained in a test setup.

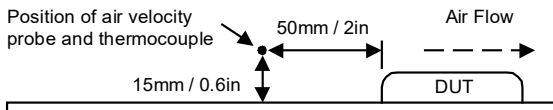

Remote On/Off Implementation

Only one type of remote ON/OFF control is available for MSCWI02. The module will turn on during the ON/OFF pin open or high impedance between ON/OFF pin and -Vin pin. The module will turn off if the ON/OFF pin is applied with a current of 2~4mA.

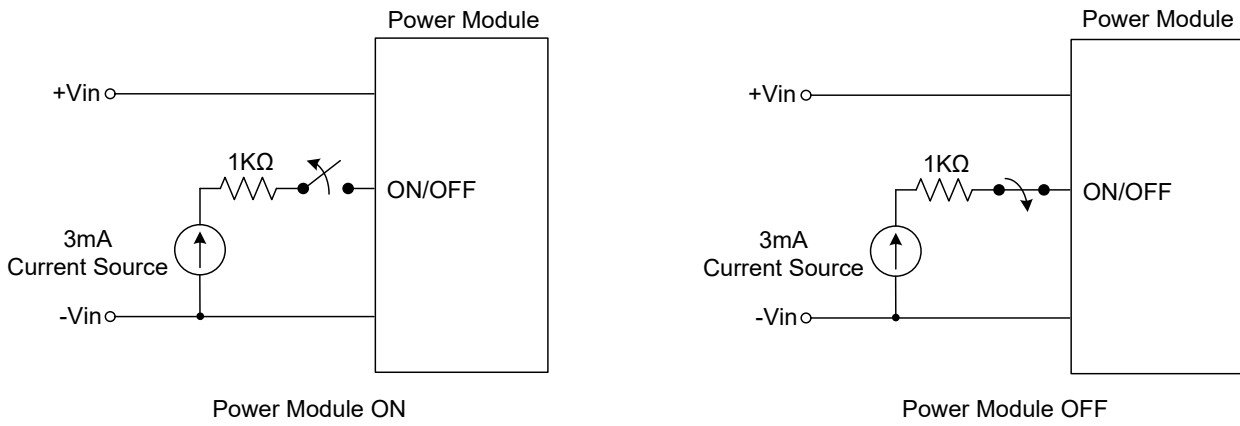

Packaging Information for Tube

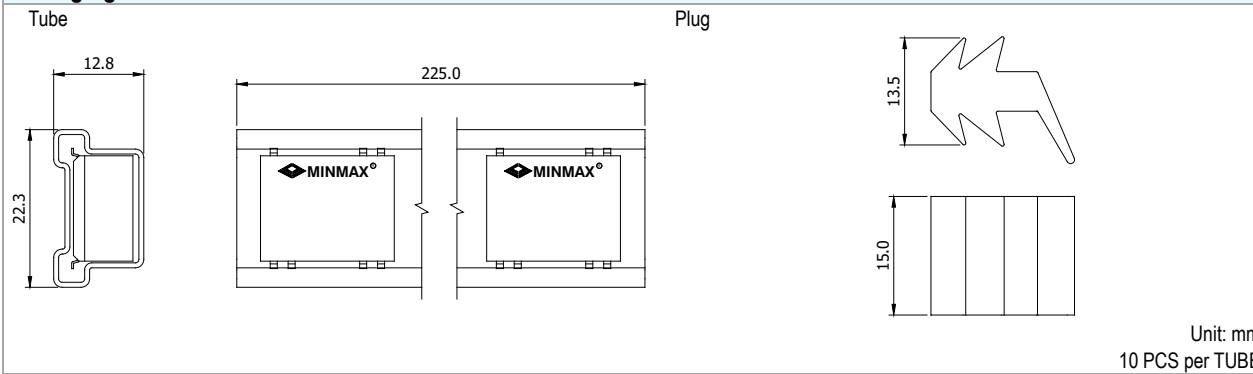

Packaging Information for Tape & Reel

Tape

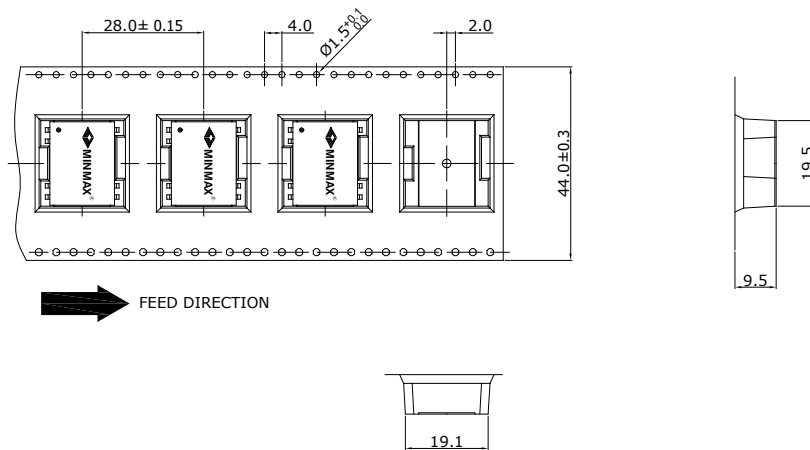

Reel

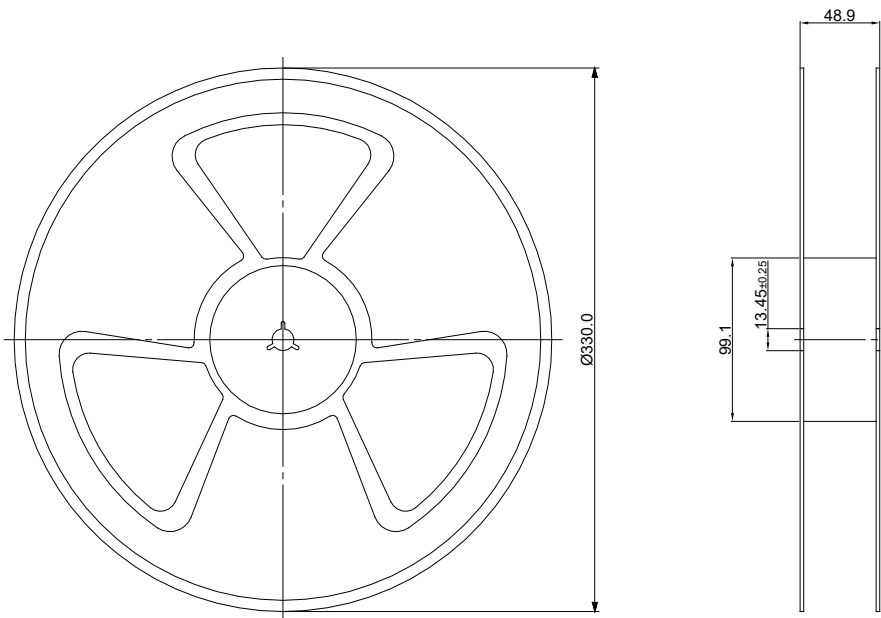

Packaging Style	Quantity
With Heatsink Tube	N/A
Tape and Reel to IEC 286-3 Specifications	250

Soldering and Reflow Considerations

Profile	Sn-Pb Eutectic Assembly	Pb-Free Assembly
Average ramp-up rate(T_s max. To T_p)	3°C/second max.	3°C/second max.
Preheat <ul style="list-style-type: none"> · Temperature Min (T_{smin}) · Temperature Max (T_{smax}) · Time (T_{smin} to T_{smax}) (t_s) 	100°C 150°C 60~120 seconds	150°C 200°C 60~180 seconds
Time maintained above: <ul style="list-style-type: none"> · Temperature (T_L) · Time (t_L) 	183°C 60~150 seconds	217°C 60~150 seconds
Peak Temperature (T_p)	See Table 4-1	See Table 4-2
Time within 5°C of actual Peak Temperature (t_p) ²	10~30 seconds	20~40 seconds
Ramp-down Rate	6°C/second max.	6°C/second max.
Time 25°C to Peak Temperature	6 minutes max.	8 minutes max.

Note 1: All temperatures refer to topside of the package, measured on the package body surface.

Note 2: Time within 5°C of actual peak temperature (t_p) specified for the reflow profiles is a "supplier" minimum and "user" maximum.

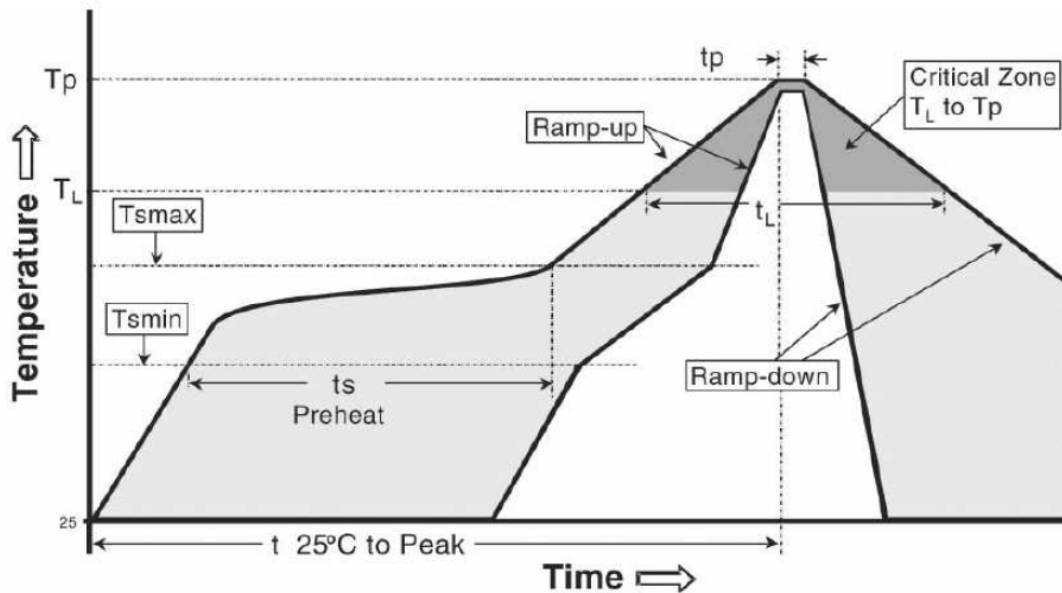

Table 4-1 SnPb Eutectic Process-Classification Temperatures (T_c)

Package Thickness	Volume mm ³	Volume mm ³
	<350	≥350
<2.5mm	235°C	220°C
≥2.5mm	220°C	220°C

Table 4-2 Pb-Free Process-Classification Temperatures (T_c)

Package Thickness	Volume mm ³	Volume mm ³	Volume mm ³
	<350	350-2000	>2000
<1.6mm	260°C	260°C	260°C
1.6mm-2.5mm	260°C	250°C	245°C
>2.5mm	250°C	245°C	245°C

Part Number Structure

M	SC	WI	02	-	05	S	05
Package Type SMD-14	Ultra-wide 4:1 Input Voltage Range	Output Power 2 Watt	Input Voltage Range			Output Quantity	Output Voltage
			05: 4.5 ~ 12 VDC		S: Single	05: 5 VDC	
			24: 9 ~ 36 VDC		D: Dual	12: 12 VDC	
			48: 18 ~ 75 VDC			15: 15 VDC	
						24: 24 VDC	

MTBF and Reliability

The MTBF of MSCWI02 series of DC-DC converters has been calculated using

MIL-HDBK 217F NOTICE2, Operating Temperature 25°C, Ground Benign.

Model	MTBF	Unit
MSCWI02-05S05	7,237,000	Hours
MSCWI02-05S12	7,369,000	
MSCWI02-05S15	7,162,000	
MSCWI02-05S24	7,247,000	
MSCWI02-05D12	6,783,000	
MSCWI02-05D15	6,432,000	
MSCWI02-24S05	7,352,000	
MSCWI02-24S12	7,549,000	
MSCWI02-24S15	7,432,000	
MSCWI02-24S24	7,234,000	
MSCWI02-24D12	6,966,000	
MSCWI02-24D15	6,718,000	
MSCWI02-48S05	7,352,000	
MSCWI02-48S12	7,256,000	
MSCWI02-48S15	7,278,000	
MSCWI02-48S24	7,394,000	
MSCWI02-48D12	6,904,000	
MSCWI02-48D15	6,664,000	